



TRADE 2020

IT - EN - FR - DE

cadelsrl.com

FEATURES

TECNOLOGIA - TECHNOLOGY - TECHNOLOGIE - TECHNOLOGIE

 Coclea in alluminio
Aluminium auger
Vis sans fin en aluminium
Aluminium-schnecke

NEW
 Uscita concentrica integrata 80 - 130 mm
Integrated concentric outlet 80 - 130 mm
Sortie concentrique intégrée 80 - 130 mm
Integrierter konzentrischer Auslass 80 - 130 mm

 Cucinare
Cooking
Cuisiner
Kochen

 Camera stagna
Sealed chamber
Chambre étanche
Dichtes Verbrennungsraum

OPTIONAL
 Kit concentrico (opzionale)
Concentric flue kit (optional)
Kit de système concentrique (optionnel)
Kit für konzentrisches Ableitungssystem (optional)

 Porta in ghisa
Cast iron door
Porte en fonte
Gusseisentür

 Braciere in ghisa
Cast iron burning pot
Brasero en fonte
Brennschale aus Gusseisen

 Interno in refrattario con aria 2ª combustione
Refractory stone inner with 2nd combustion air
Intérieur réfractaire à apport d'air secondaire
Feuerraum aus Schamotte mit Sekundärluftverbrennung

 Vista sul forno
View on the oven
Vue sur le four
Sicht des Backofens

 Magic Glass

 Interno in ghisa con aria 2ª combustione
Cast iron inner with 2nd combustion air
Intérieur fonte à apport d'air secondaire
Feuerraum aus Gusseisen mit Sekundärluftverbrennung

NEW
 Una innovativa caldaia composta da due gusci in acciaio alluminato
An innovative boiler composed of two aluminised steel shells
Une chaudière innovante composée de deux coques en acier aluminisé
Ein innovativer Kessel, der aus zwei Schalen aus Aluminiumstahl besteht

MODALITÀ D'USO - CONDITIONS OF USE - MODE D'EMPLOI - GEBRAUCHSANWEISUNGEN

 **ON/OFF**
Comfort mode

NEW
 Wi-Fi integrato
Integrated Wi-Fi
Wi-Fi intégré
Integriertes WIFI

 **H₂O VERSION**
Kit completo Idro riscaldamento + acqua sanitaria
Complete kit heating + domestic water
Kit complet Idro chauffage + eau sanitaire
Komplett-Set Hydro Heizung + Brauchwasser

 Collegamento termostato esterno
Connection to the external thermostat
Liaison thermostat externe
Anschluss zu Außenthermostat

OPTIONAL
 Wi-Fi (opzionale)
Wi-Fi kit (optional)
Wi-Fi (optionnel)
Wi-Fi (optional)

 Telecomando
Remote control
Télécommande
Fernbedienung

 Programmazione giornaliera settimanale
Daily weekly programming
Programmation journalière hebdomadaire
Programmierung Tag - Woche

 Sensore di temperatura aria
Air temperature sensor
Capteur de température de l'air
Temperaturfühler

 Sensore di temperatura acqua
Water temperature sensor
Capteur de température de l'eau
Wassertemperaturfühler

 Ventilazione + luce (opzionale)
Ventilation + light kit (optional)
Ventilation + éclairage (optionnel)
Lüftung kit + Beleuchtung (optional)

 Canalizzazione 1 motore indipendente
Duction with 1 independent motor
Conduits d'aération avec 1 moteur indépendant
Kanalisation mit 1 unabhängigen Luftgebläse

 Canalizzazione 2 motori indipendenti
Duction with 2 independent motors
Conduits d'aération avec 2 moteurs indépendants
Kanalisation mit 2 unabhängigen Luftgebläsen

 Collegamento all'impianto di riscaldamento
Connection to the heating system
Raccordement avec installation de chauffage
Anschluss zu Heizungssystem

 **KIT**
Kit canalizzazione (opzionale)
Ducting kit (optional)
Kit conduits de canalisation (optional)
Kit für Kanalisation (optional)

 **GO!**
Kit idraulico incluso
Hydraulic kit included
Kit hydraulique inclus
Hydrauliksatz enthalten

MODALITÀ D'INSTALLAZIONE - INSTALLATION MODE - MODE D'INSTALLATION - EINBAUBEDINGUNGEN

 Scarico fumi superiore, posteriore e laterale
Upper, back and lateral exhaust
Sortie fumée supérieure, postérieure et latéral
Abgasstutzen Hinten, Seitlich, Oben

 Scarico fumi superiore e posteriore
Upper and back exhaust
Sortie fumée supérieure et postérieure
Abgasstutzen Hinten u. Oben

 Scarico fumi superiore
Upper exhaust
Sortie fumée supérieure
Abgasstutzen Oben

 Scarico fumi posteriore
Back exhaust
Sortie fumée postérieure
Abgasstutzen Hinten

 Scarico fumi laterale
Lateral exhaust
Sortie fumée latéral
Abgasstutzen Seitlich

NEW
 Canalizzazione superiore e posteriore
Top and rear ducting
Canalisation supérieure et arrière
Obere und hintere Kanalisation

 Built-in

 Free Standing





PELLET AIR

pag. 8



PELLET AIR PLUS

pag. 70



Possibilità di canalizzare 1 dei 2 motori
Option of ducting 1 of the 2 motors
Possibilité de canaliser 1 des 2 moteurs
Möglichkeit, einen der zwei Motoren zu kanalisieren



PELLET HYDRO

pag. 98



CUCINE A LEGNA

WOOD COOKERS - CUISINES À BOIS - HOLZHERDE

pag. 128

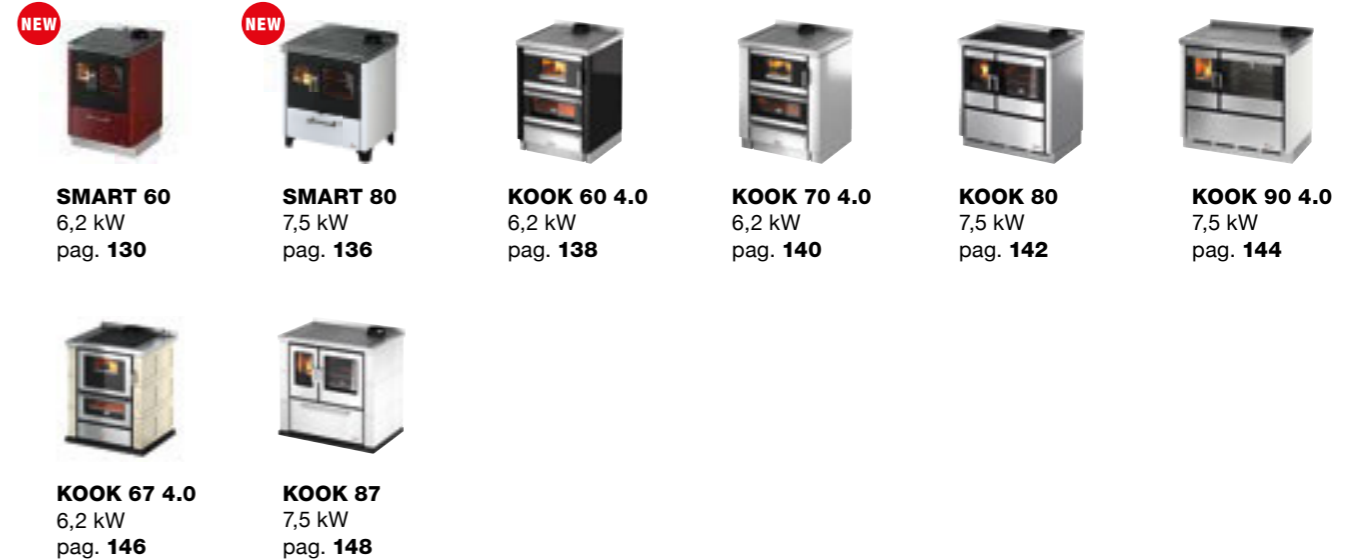



AFFIDABILITÀ, ESTETICA E CONVENIENZA

I Plus che rendono le stufe Cadel la scelta ideale per riscaldare e arredare la tua casa.

RELIABILITY, AESTHETICS AND CONVENIENCE

The Pluses that make Cadel stoves the ideal choice for heating and decorating your home.

FIABILITÉ, ESTHÉTIQUE ET AVANTAGES

Les Plus qui font des poêles Cadel le bon choix pour chauffer et meubler votre maison.

ZUVERLÄSSIGKEIT, ÄSTHETIK UND GÜNSTIGER PREIS

Warum Cadel-Öfen die ideale Wahl für das Heizen und die Einrichtung Ihrer Wohnung sind.

WIFI INTEGRATO

La connessione wifi consente di gestire le funzioni di base dei nostri prodotti a pellet tramite la nuova ed intuitiva app **Easy Connect Plus**: da qualunque luogo in cui ci troviamo consente la gestione domotica locale e remota della stufa. Comandare e monitorare l'apparecchio diventa facile, basta avere uno smartphone o tablet e una connessione dati disponibile.

Le funzioni principali gestibili tramite app sono: accendere e spegnere la stufa, aumentare o diminuire sia la potenza che la temperatura ambiente, impostare il cronotermostato giornaliero e settimanale e visualizzare lo stato del prodotto.

Il Wi-Fi integrato è disponibile di serie sulle seguenti stufe: Rondo³, Shell³ Up-Ps, Frame³ Up, Zefiro³, Tile³ Plus, Atena³ Plus 12-14, Saturno 16-24.



INTEGRATED WI-FI

The wi-fi connection allows you to manage the basic functions of our pellet products through the new and intuitive **Easy Connect Plus** app: no matter where you are, you can manage the stove's local and remote home automation. Controlling and monitoring the product is easy, all you need is a smartphone or tablet and a data connection.

The main functions that can be managed through the app are: turning the stove on and off, raising and lowering both power and room temperature, setting the daily and weekly programmable thermostat and viewing the state of the product.

Integrated wi-fi is a standard feature on the following stoves: Rondo³, Shell³ Up-Ps, Frame³-Up, Zefiro³, Tile³ Plus, Atena³ Plus 12-14, Saturno 16-24.

WI-FI INTÉGRÉ

La connexion Wi-Fi permet de gérer les fonctions de base de nos produits à pellet via la nouvelle appli intuitive **Easy Connect Plus** : où que nous soyons, elle permet une gestion domotique locale et à distance du poêle. L'utilisation et la surveillance de l'appareil deviennent faciles, il suffit d'avoir un smartphone ou une tablette et de disposer d'une connexion de données.

Les principales fonctions qui peuvent être gérées via l'application sont : allumer et éteindre le poêle, augmenter ou diminuer la puissance et la température ambiante, régler le thermostat programmable quotidien et hebdomadaire et afficher l'état du produit.

Le Wi-Fi intégré est disponible de série sur les poêles suivants : Rondo³, Shell³ Up-Ps, Frame³-Up, Zefiro³, Tile³ Plus, Atena³ Plus 12-14, Saturno 16-24.

INTEGRIERTES WIFI

Über die WiFi-Verbindung können die Grundfunktionen unserer Pelletgeräte mit der neuen, intuitiven App „**Easy Connect Plus**“ gesteuert werden. So können Sie von überall aus die Domotik Ihrer Wohnung und den Ofen fernsteuern. Damit wird es ganz leicht, das Gerät zu steuern und zu überwachen. Ein Smartphone oder Tablet und eine Datenverbindung reichen aus.

Die wichtigsten über die App steuerbaren Funktionen sind: Ein- und Ausschalten des Ofens, Erhöhen oder Senken der Leistung und der Raumtemperatur, Einstellen des Zeitthermostats für den Tag oder die Woche und Anzeigen des Gerätezustands.

Das integrierte WiFi ist serienmäßig bei den folgenden Öfen verfügbar: Rondo³, Shell³ Up-Ps, Frame³-Up, Zefiro³, Tile³ Plus, Atena³ Plus 12-14, Saturno 16-24.

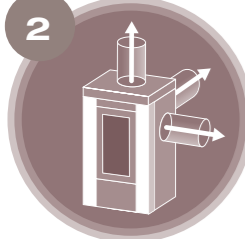

VERSATILITÀ

Versatilità di uscita scarico fumi: superiore, posteriore, laterale e coassiale.

VERSATILITY

Versatility of the smoke outlet: top, rear, side and coaxial.

POLYVALENCE

Polyvalence de la sortie d'évacuation des fumées : supérieure, arrière, latérale et coaxiale.

FLEXIBILITÄT

Flexibilität beim Rauchgasabzug: oben, hinten, seitlich und koaxial.

CAMERA STAGNA

Stufe a pellet completamente ermetiche rispetto all'ambiente di installazione: prelevano l'aria di combustione direttamente dall'esterno e non dal locale in cui sono installate.

- Meno emissioni
- Più sicurezza
- Maggior rendimento

SEALED CHAMBER

Pellet stoves that are completely sealed in relation to the room of installation: they draw combustion air directly from outdoors and not from the room they are installed in.

- Fewer emissions
- More safety
- Greater efficiency

CHAMBRE ÉTANCHE

Ces poêles à pellets sont parfaitement hermétiques par rapport à l'environnement d'installation : ils prélèvent l'air de combustion de l'extérieur directement et non pas du local dans lequel ils sont installés.

- Moins d'émissions
- Plus de sécurité
- Meilleur rendement

ABGEDICHTETE KAMMER

Vollkommen gegen die Installationsumgebung abgedichtet: Die Verbrennungsluft wird direkt von außen angesaugt, nicht aus dem Raum, in dem der Ofen installiert ist.

- Weniger Emissionen
- Mehr Sicherheit
- Höherer Wirkungsgrad

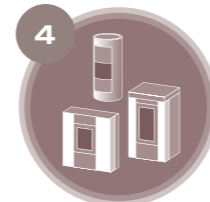
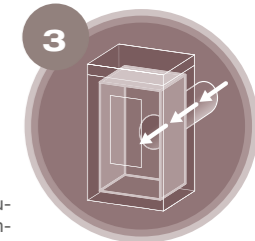

GAMMA

Ampia scelta tra forme (slim, tonda, piccola, quadrata...), dimensioni e potenze diverse.

RANGE

Wide range of shapes (slim, round, small, square...), sizes and powers.

GAMME

Large choix de formes (slim, rond, petit, carré...), différentes tailles et puissances.

SERIE

Große Auswahl an Formen (slim, rund, klein, quadratisch...), Größen und Leistungen.



INNOVAZIONE E FLESSIBILITÀ PRODUTTIVA

Grazie a sistemi avanzati di industrializzazione, metodi JIT, Kanban e lean management.

INNOVATION AND PRODUCTION FLEXIBILITY

Through advanced industrialisation systems, JIT, Kanban and lean management methods.

INNOVATION ET FLEXIBILITÉ DE PRODUCTION

Grâce aux systèmes avancés d'industrialisation ainsi qu'aux méthodes JIT, Kanban et au lean management.

INNOVATION UND FLEXIBILITÄT BEI DER PRODUKTION

Dank innovativer Industriesysteme und Methoden aus JIT, Kanban und Lean Management.



TELECOMANDO

Un comodo telecomando in dotazione per gestire a distanza la stufa: on/off, set temperatura, potenza ventilatori, programmazione settimanale. (Eccetto per il modello Spirit³).

REMOTE CONTROL

A convenient remote control is provided with the stove: on/off, temperature setting, fan power, weekly programming. (Except with the Spirit³ model).

TÉLÉCOMMANDE

Une télécommande pratique permet de gérer le poêle à distance : allumage/arrêt, consigne de température, puissance des ventilateurs, programmation hebdomadaire. (Sauf sur le modèle Spirit³).

FERNBEDIENUNG

Eine Fernbedienung, mit der der Ofen bequem von Weitem gesteuert werden kann: Ein/Aus, Einstellen der Temperatur und der Gebläseleistung, Wochenprogrammierung. (Außer beim Modell Spirit³).



VENTILATORI INDIPENDENTI

Grazie al sistema canalizzazione dell'aria calda in altri ambienti, con le stufe **Air Plus** è possibile distribuire in più stanze della stessa casa il calore in modo omogeneo. A seconda delle esigenze si può scegliere una stufa canalizzabile a due o tre uscite: tutti i ventilatori possono essere gestiti in modo indipendente.

INDEPENDENT FANS

Thanks to the ductable system that conveys hot air to other rooms, with **Air Plus** pellet stoves heat can be evenly distributed in several rooms of the same house. Depending on your needs, you can choose a ductable stove with two or three outlets: all fans can be controlled separately.

VENTILATEURS INDÉPENDANTS

Grâce au système de canalisations d'air chaud dans d'autres pièces, les poêles à pellets **Air Plus** permettent de répartir la chaleur de manière homogène dans plusieurs pièces d'une même maison. En fonction de ses besoins, on peut choisir un poêle canalisable avec deux ou trois sorties : tous les ventilateurs peuvent être gérés de manière indépendante.

UNABHÄNGIGE VENTILATOREN

Über das Kanalisierungssystem kann bei den Pelletöfen **Air Plus** die warme Luft in mehrere Räume geleitet werden, um diese gleichmäßig zu heizen. Der kanalisierbare Ofen ist je nach Bedarf mit zwei oder drei Luftauslässen erhältlich. Alle Ventilatoren können dabei unabhängig gesteuert werden.



COMFORT MODE

Disattiva automaticamente i ventilatori della stufa a potenza 1 per garantire la massima silenziosità.

This automatically deactivates the stove fans to power 1 to guarantee maximum silence.

Les ventilateurs sont automatiquement désactivés quand le poêle est à la puissance 1 afin de garantir le maximum de silence.

Schaltet automatisch alle Ventilatoren des Ofens auf Stufe 1 aus, um so geräuscharm wie möglich zu arbeiten.

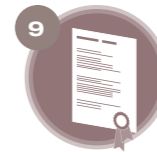

CERTIFICAZIONI

Prodotti certificati secondo le normative europee.

CERTIFICATIONS

Products certified according to European regulations.

CERTIFICATIONS

Produits certifiés selon les normes européennes.

ZERTIFIZIERUNGEN

Die Geräte sind nach den europäischen Richtlinien zertifiziert.



PELLET AIR

Cadel offre una gamma completa di stufe a pellet ad aria ventilata dotate di camera stagna per un maggior rendimento e minor consumo. **Tutti i modelli di stufe Pellet Air sono certificati Classe Energetica A+, 4 stelle Aria Pulita, 7 stelle Flamme Verte e sono riconosciuti come idonei a ricevere il rimborso Conto Termico.**

Cadel offers a comprehensive range of ventilated air pellet stoves with a sealed chamber for greater efficiency and reduced consumption.

All Pellet Air Stove models are conform with the EcoDesign 2022 directives.

Cadel propose une gamme complète de poêles à pellets à air ventilé équipés d'une chambre étanche pour un meilleur rendement et une moindre consommation.

Tous les modèles de poeles Pellet Air sont certifiés 7 étoiles Flamme Vert et sont reconnus comme éligibles au crédit d'impôt. En outre, un an après leur introduction, ils sont référencés CSTB.

Cadel bietet eine vollständige Palette von Pelletöfen mit Gebläse und abgedichteter Brennkammer zur Gewährleistung von höherer Leistung und geringerem Verbrauch.

Alle Pelletofen Modelle der Linie Air sind Bimsch 2015 (Regensburg, München, Stuttgart, Aachen) und Klima Energiefonds zertifiziert.



SHIELD

UN NUOVO CUORE PULSA NELLE STUFE CADEL:

Una innovativa caldaia composta da due gusci in acciaio alluminato dove al suo interno avviene una perfetta combustione del pellet.

Un'unica scocca per un'infinità di vantaggi:

- Maggiore superficie di scambio termico
- Maggiore resistenza meccanica
- Maggiore rifrazione della fiamma
- Migliore rendimento
- Minori emissioni
- Minori consumi
- Minor impatto ambientale nella realizzazione della caldaia

A NEW BEATING HEART OF CADEL STOVES:

An innovative boiler composed of two aluminised steel shells inside of which perfect pellet combustion occurs.

A single body for countless advantages:

- More surface area for thermal exchange
- Greater mechanical resistance
- Greater flame refraction
- Better efficiency
- Lower emissions
- Lower consumption
- Lower environmental impact in the manufacture of the boiler

UN NOUVEAU CŒUR BAT DANS LES POÊLES CADEL :

Une chaudière innovante composée de deux coques en acier aluminisé garantit à l'intérieur une combustion parfaite du pellet.

Un corps unique pour un nombre infini d'avantages :

- Plus grande surface d'échange thermique
- Plus grande résistance mécanique
- Plus grande réfraction de la flamme
- Meilleur rendement
- Moins d'émissions
- Moindres consommations
- Impact environnemental réduit lors de la réalisation de la chaudière

IN DEN ÖFEN VON CADEL SCHLÄGT EIN NEUES HERZ:

Ein innovativer Kessel, der aus zwei Schalen aus Aluminiumstahl besteht und in dem eine perfekte Verbrennung der Pellets erfolgt.

Nur ein Gehäuse für eine Vielzahl an Vorteilen:

- Größere Wärmeaustauschfläche
- Höhere mechanische Festigkeit
- Bessere Lichtbrechung
- Höherer Wirkungsgrad
- Weniger Emissionen
- Geringerer Verbrauch
- Weniger Auswirkungen auf die Umwelt bei der Herstellung des Kessels





SPIRIT³ 5

NEW

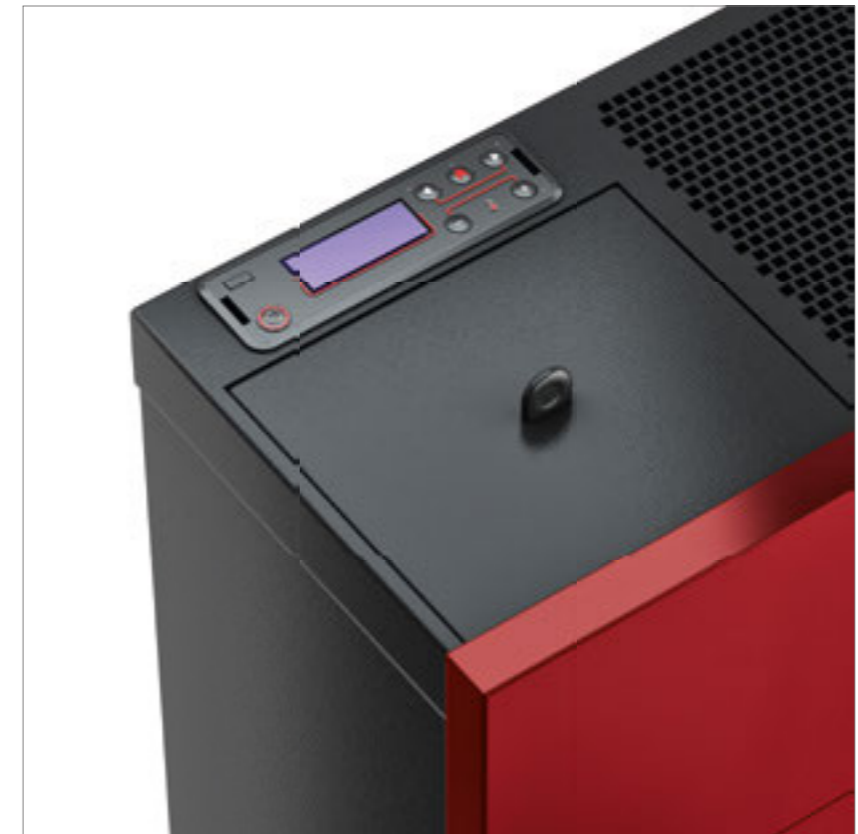

Una stufa dalle forme snelle e compatte, un design moderno ideale per ambienti dalle dimensioni contenute, dotata di camera stagna, porta e braciere in ghisa e possibilità di scarico fumi superiore, posteriore e laterale.

A stove in sleek, compact shape, a modern design ideal for rooms with limited dimensions, fitted with a sealed chamber, a cast iron brazier and door and the possibility of a top, rear and side smoke outlet.

Un poêle aux formes harmonieuses et compactes, un design moderne idéal pour les pièces aux dimensions réduites, doté de chambre étanche, d'une porte et d'un brasier en fonte et avec possibilité d'évacuation des fumées supérieure, postérieure et latérale.

Ein Ofen mit schlanken, kompakten Formen und modernem Design, ideal für nicht sehr große Räume, mit abgedichteter Kammer, Tür und Brennschale aus Gusseisen und der Möglichkeit, den Rauchabzug oben, hinten oder seitlich zu haben.



SPIRIT³ 5

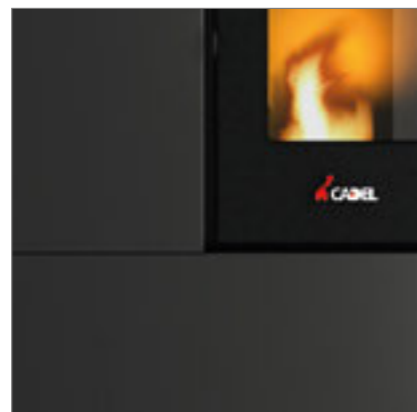
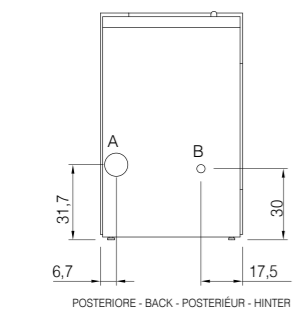
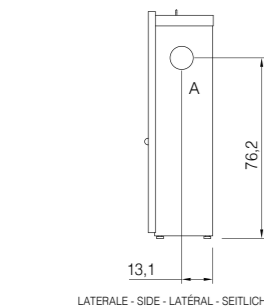
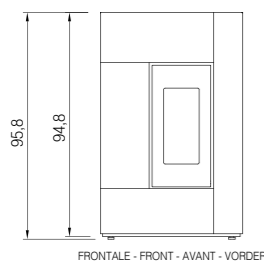
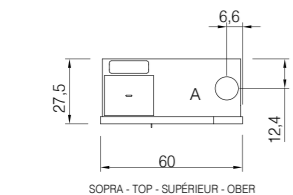

EUROPEAN STANDARDS

Art. 15A B-VG 2015
BlmSchV 2015
Regensburg
München
Stuttgart
Aachen



EN 14785:2006



ENERGY LABELLING



TECHNICAL DATA

5,2 kW



5,2 kW



2,5 kW



89,5%



91,5%



0,57 kg/h
1,24 kg/h



9,7 h
21,1 h



60 m³
125 m³



55 kg



L 107 cm
P 80 cm
H 44,8 cm



0,38 m³



40,5 dB
42,5 dB



Pellet
Ø 6 mm



12 kg



Ø 80 mm



Ø 60 mm



Telecomando
Remote Control
Télécommande
Fernbedienung



Kit curva 90° per uscita fumi posteriore - laterale
90° bend kit for rear - side smoke outlet
Kit coude à 90° pour sortie des fumées arrière - latérale
Bausatz 90°-Krümmung für Rauchgasauslass hinten/an der Seite



Metallo Bianco
White Steel
Acier Blanc
Metall Weiss



Metallo Rosso
Red Steel
Acier Rouge
Metall Rot



Metallo Antracite
Anthracite Steel
Acier Anthracite
Metall Anthrazit

SPIRIT³ 5

7019084		EAN 8053859011866	Metallo Bianco / White Steel / Acier Blanc / Metall Weiss
7019083		EAN 8053859011859	Metallo Rosso / Red Steel / Acier Rouge / Metall Rot
7019085		EAN 8053859011873	Metallo Antracite / Anthracite Steel / Acier Anthracite / Metall Anthrazit

OPTIONAL

5020001	EAN 8053859012474	NEW Kit curva 90° per uscita fumi posteriore - laterale / 90° bend kit for rear - side smoke outlet / Kit coude à 90° pour sortie des fumées arrière - latérale / Bausatz 90°-Krümmung für Rauchgasauslass hinten/an der Seite
5019012	EAN 805385901165	Telecomando / Remote Control / Télécommande / Fernbedienung





RONDÒ³



Una delle stufe a pellet tonde e stagne più piccole nel mercato, un evergreen di successo che si integra con classe e personalità in ogni ambiente. La nuova versione, più alta della precedente, ha un nuovo display integrato e una nuova maniglia.

One of the smallest round, sealed stoves on the market., a successful classic that blends in every environment with class and personality. The new version, higher than the previous one, has a new integrated display and a new handle.

L'un des poêles à pellets ronds et étanches les plus petits du marché, un succès indémodable qui s'insère avec classe et personnalité dans tout type de décor. La nouvelle version, plus haute que la précédente, a un nouvel écran intégré et une nouvelle poignée.

Einer der kleinsten runden, gassdichten Pelletöfen auf dem Markt, ein erfolgreicher Evergreen, der mit seiner Klasse und Persönlichkeit in jedem Raum seinen Platz finden kann. Die neue Ausführung, die höher ist als die vorherige, hat ein neues Display und einen neuen Griff.





RONDÒ³

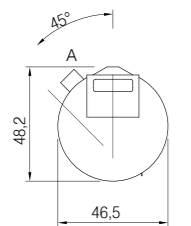

SOPRA - TOP - SUPÉRIEUR - OBER

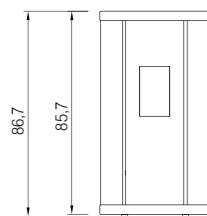

FRONTALE - FRONT - AVANT - VORDER

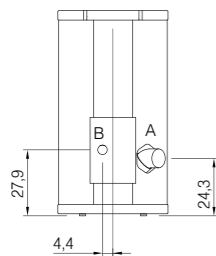

POSTERIORE - BACK - POSTÉRIEUR - HINTER



EUROPEAN STANDARDS

Art. 15A B-VG 2015
BlmSchV 2015
Regensburg
München
Stuttgart
Aachen



EN 14785:2006



ENERGY LABELLING



TECHNICAL DATA

6,5 kW



6,5 kW



2,4 kW



91%



94,5%



0,50 kg/h
1,50 kg/h



8 h
24 h



58 m³
156 m³



68 kg



L 80 cm
P 60 cm
H 114,3 cm



0,55 m³



43,9 dB
54,7 dB



Pellet
Ø 6 mm



12 kg



A Ø 80 mm



B Ø 60 mm



Kit scarico sup.
Upper exhaust kit
Kit sortie fumée sup.
Kit Abgasstutzen oben



Metallo Bianco
White Steel
Acier Blanc
Metall Weiss



Metallo Rosso
Red Steel
Acier Rouge
Metall Rot



Metallo Dark Bronze
Dark Bronze Steel
Acier Dark Bronze
Metall Dark Bronze



Metallo Antracite
Anthracite Steel
Acier Anthracite
Metall Anthrazit

RONDÒ³

7019015		EAN 8053859010746	Metallo Bianco / White Steel / Acier Blanc / Metall Weiss
7019016		EAN 8053859010753	Metallo Rosso / Red Steel / Acier Rouge / Metall Rot
7019017		EAN 8053859010760	Metallo Dark Bronze / Dark Bronze Steel / Acier Dark Bronze / Metall Dark Bronze
7019014		EAN 8053859010739	Metallo Antracite / Anthracite Steel / Acier Anthracite / Metall Anthrazit

OPTIONAL

5019003	EAN 8053859010968	Kit scarico sup. / Upper exhaust kit / Kit sortie fumée sup. / Kit Abgasstutzen oben
---------	-------------------	--





GRACE³



La stufa a pellet che arreda. Il suo design elegante e contemporaneo la rendono particolarmente adatta agli spazi ristretti. Ora disponibile anche nella versione con rivestimento in vetro nero.

The pellet stove that furnishes. Its elegant and contemporary design makes it particularly suitable for confined spaces. Now also available in the version with black glass cladding.

Le poêle à pellets qui décore. Son design élégant et contemporain le rend particulièrement approprié aux espaces réduits. À présent disponible aussi dans la version avec revêtement en verre noir.

Der Pelletofen, der als Einrichtungsgegenstand gilt. Dank seinem eleganten und zeitgenössischen Design ist er für enge Platzverhältnisse besonders geeignet. Jetzt auch in einer Ausführung mit Verkleidung aus schwarzem Glas erhältlich.



GRACE³



Top estetico dotato di un pretaglio smart per installazione uscita superiore.

Aesthetic top with smart precut for the installation of a top outlet.

Couvercle esthétique doté d'une pré-découpe smart pour installer la sortie supérieure.

Zierblende oben mit intelligentem Vorschnitt zur Installation eines oberen Auslasses.



GRACE³

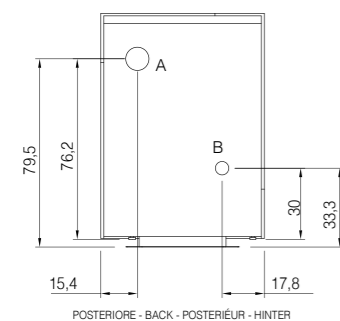
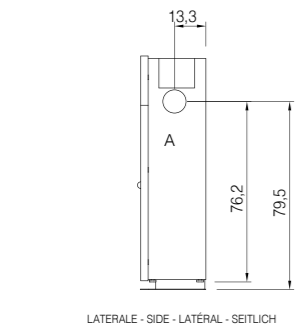
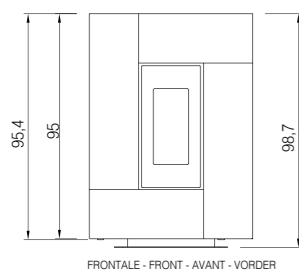
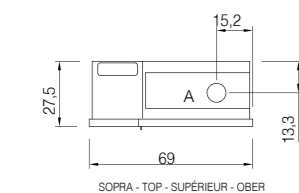

EUROPEAN STANDARDS

BImSchV 2015
Regensburg
München
Stuttgart
Aachen



EN 14785:2006



ENERGY LABELLING



TECHNICAL DATA

7 kW



7 kW



2,7 kW

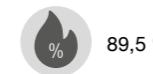

89,5 %

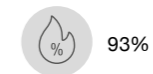

93%



0,61 kg/h
1,70 kg/h



7,1 h
19,7 h



65 m³
168 m³

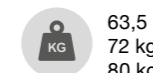

63,5 kg
72 kg
80 kg



L 107 cm
P 80 cm
H 44,8 cm



0,38 m³



40,5 dB
42,5 dB



Pellet
Ø 6 mm



12 kg



Ø 80 mm



Ø 60 mm



Piedistallo estetico
Decorative stand
Socle esthétique
Ästhetischer Sockel



Kit supporto a parete Wall
support kit
Kit support mural
Bausatz Wandhalterung



Kit curva 90° per uscita fumi posteriore - laterale
90° bend kit for rear - side smoke outlet
Kit coude à 90° pour sortie des fumées arrière - latérale
Bausatz 90°-Krümmung für Rauchgasauslass hinten/an der Seite



Vetro Nero
Black Glass
Verre Noir
Glas Schwarz



Metallo Bianco
White Steel
Acier Blanc
Metall Weiss



Metallo Rosso
Red Steel
Acier Rouge
Metall Rot



Metallo Light Bronze
Light Bronze Steel
Acier Light Bronze
Metall Light Bronze



Metallo Antracite
Anthracite Steel
Acier Anthracite
Metall Anthrazit



Pietra Serpentino
Serpentino Stone
Pierre Serpentino
Stein Serpentino

GRACE³

7019024	EAN 8053859010838	Neutra / neutral / neutre / neutral
6920001	EAN 8053859012467	NEW Vetro Nero / Black Glass / Verre Noir / Glas Schwarz
6919016	EAN 8053859010845	Metallo Bianco / White Steel / Acier Blanc / Metall Weiss
6919020	EAN 8053859010944	Metallo Light Bronze / Light Bronze Steel / Acier Light Bronze / Metall Light Bronze
6919017	EAN 8053859010852	Metallo Rosso / Red Steel / Acier Rouge / Metall Rot
6919018	EAN 8053859010869	Metallo Antracite / Anthracite Steel / Acier Anthracite / Metall Anthrazit
6919019	EAN 8053859010876	Pietra Serpentino / Serpentino Stone / Pierre Serpentino / Stein Serpentino

OPTIONAL

5019005	EAN 8053859010951	Piedistallo estetico / Decorative stand / Socle esthétique / Ästhetischer Sockel
5019009	EAN 8053859011736	Kit supporto a parete / Wall support kit / Kit support mural / Bausatz Wandhalterung
5020001	EAN 8053859012474	NEW Kit curva 90° per uscita fumi posteriore - laterale / 90° bend kit for rear - side smoke outlet / Kit coude à 90° pour sortie des fumées arrière - latérale / Bausatz 90°-Krümmung für Rauchgasauslass hinten/an der Seite





CRISTAL³ 7

NEW

La gamma Cristal³ si allarga.
Una potenza di 7 kW e un ottimo rapporto qualità prezzo caratterizzano questa nuova stufa funzionale.

The Cristal³ range has been extended.
This new functional stove features 7 kW of power and an excellent price/quality ratio.

La gamme Cristal³ s'agrandit.
7 kW de puissance et un excellent rapport qualité-prix caractérisent ce nouveau poêle fonctionnel.

Die Baureihe Cristal³ vergrößert sich.
Dieser neue, funktionale Ofen zeichnet sich durch 7 kW Leistung und ein hervorragendes Preis-Leistungs-Verhältnis aus.





CRISTAL³ 7

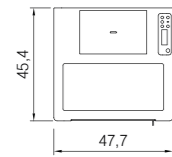

SOPRA - TOP - SUPÉRIEUR - OBER

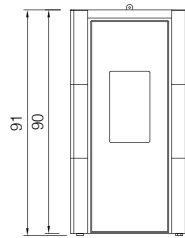

FRONTALE - FRONT - AVANT - VORDER

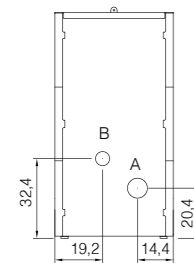

POSTERIORE - BACK - POSTÉRIEUR - HINTER



EUROPEAN STANDARDS

BImSchV 2015
Regensburg
München
Stuttgart
Aachen



EN 14785:2006



ENERGY LABELLING



TECHNICAL DATA

7 kW



7 kW



2,6 kW



90%



92%



0,56 kg/h
1,65 kg/h



9,1 h
26,8 h



62 m³
168 m³



56 kg



L 80 cm
P 60 cm
H 114,3 cm



0,55 m³



40,5 dB
42,5 dB



Pellet
Ø 6 mm



15 kg



A Ø 80 mm



B Ø 60 mm



Metallo Bianco
White Steel
Acier Blanc
Metall Weiss



Metallo Rosso
Red Steel
Acier Rouge
Metall Rot



Metallo Antracite
Anthracite Steel
Acier Anthracite
Metall Anthrazit

CRISTAL³ 7

7020028		EAN 8053859012498	Metallo Bianco / White Steel / Acier Blanc / Metall Weiss
7020029		EAN 8053859012504	Metallo Rosso / Red Steel / Acier Rouge / Metall Rot
7020027		EAN 8053859012481	Metallo Antracite / Anthracite Steel / Acier Anthracite / Metall Anthrazit





SWEET³ 7

NEW

Il design curato, la semplicità d'uso, un upgrade di potenza a 7kW e un'innovativa caldaia caratterizzano il restyling della Sweet³ 7.

The restyling of Sweet³ 7 features an attractive design, ease of use, a 7kW power upgrade and an innovative burner.

Ce sont le design raffiné, la facilité d'utilisation, une puissance qui passe à 7 kW et une chaudière innovante qui caractérisent le relooking du poêle Sweet³ 7.

Das klare Design, der hohe Gebrauchskomfort, die auf 7 kW erhöhte Leistung und ein innovativer Kessel sind die Ergebnisse des Restylings des Modells Sweet³ 7.



SWEET³ 7

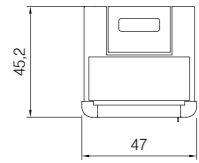

SOPRA - TOP - SUPÉRIEUR - OBER

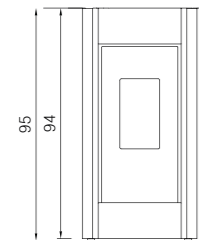

FRONTALE - FRONT - AVANT - VORDER

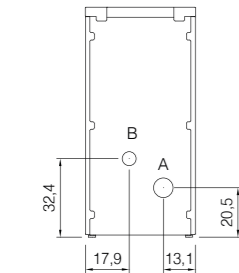

POSTERIORE - BACK - POSTÉRIEUR - HINTER



EUROPEAN STANDARDS

BlmSchV 2015
Regensburg
München
Stuttgart
Aachen



EN 14785:2006



ENERGY LABELLING



TECHNICAL DATA

7 kW



7 kW



2,6 kW



90%



92%



0,56 kg/h
1,65 kg/h



9,1 h
26,8 h



62 m³
168 m³



56 kg



L 80 cm
P 60 cm
H 114,3 cm



0,55 m³



40,5 dB
42,5 dB



Pellet
Ø 6 mm



15 kg



Ø 80 mm



Ø 60 mm



Metallo Bianco
White Steel
Acier Blanc
Metall Weiss



Metallo Rosso
Red Steel
Acier Rouge
Metall Rot



Metallo Antracite
Anthracite Steel
Acier Anthracite
Metall Anthrazit

SWEET³ 7

7020026	EAN 8053859012429	Neutra / Neutral / Neutre / Neutral
6920025	EAN 8053859012443	Metallo Bianco / White Steel / Acier Blanc / Metall Weiss
6920026	EAN 8053859012450	Metallo Rosso / Red Steel / Acier Rouge / Metall Rot
6920024	EAN 8053859012436	Metallo Antracite / Anthracite Steel / Acier Anthracite / Metall Anthrazit





PERLA³ 7

NEW

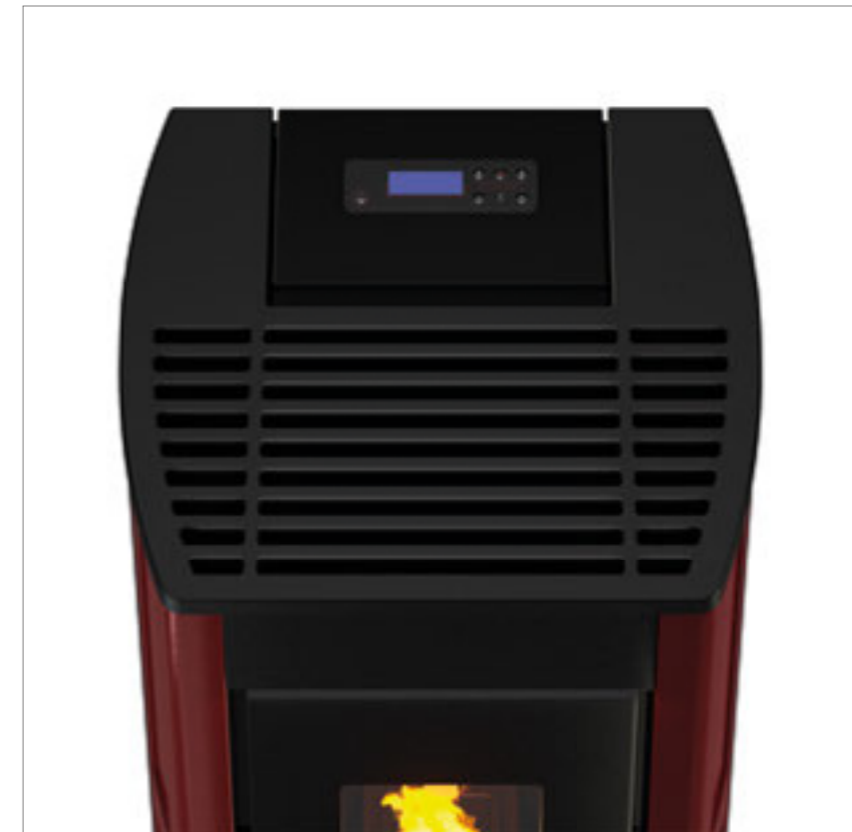

La gamma Perla³ si amplia con l'introduzione delle finiture in metallo, un nuovo design del top in ghisa e un'innovativa caldaia.

The Perla³ range has been expanded by introducing metal finishes, a new design of the cast iron top and an innovative burner has been improved.

La gamme Perla³ se développe en introduisant des finitions en métal, relooke son couvercle en fonte et une chaudière innovante.

Bei der Baureihe Perla³ kommen Metalloberflächen hinzu, ein innovativer Kessel und die gusseiserne Topplatte sorgt für anspruchsvolles Design.



PERLA³ 7

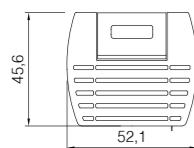

SOPRA - TOP - SUPÉRIEUR - OBER

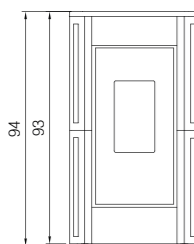

FRONTALE - FRONT - AVANT - VORDER

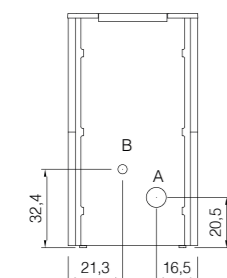

POSTERIORE - BACK - POSTÉRIEUR - HINTER

EUROPEAN STANDARDS

BImSchV 2015
Regensburg
München
Stuttgart
Aachen



EN 14785:2006



ENERGY LABELLING



TECHNICAL DATA

7 kW



7 kW



2,6 kW



90%



92%



0,56 kg/h
1,65 kg/h



9,1 h
26,8 h



62 m³
168 m³



60 kg
67 kg



L 80 cm
P 60 cm
H 114,3 cm



0,55 m³



40,5 dB
42,5 dB



Pellet
Ø 6 mm



15 kg



Ø 80 mm



Ø 60 mm



Maiolica Bianco
White Majolica
Céramique Blanc
Keramik Weiss



Maiolica Avorio
Ivory Majolica
Céramique Ivoire
Keramik Elfenbein



Maiolica Rosso
Red Majolica
Céramique Rouge
Keramik Rot



Metallo Bianco
White Steel
Acier Blanc
Metall Weiss



Metallo Rosso
Red Steel
Acier Rouge
Metall Rot



Metallo Antracite
Anthracite Steel
Acier Anthracite
Metall Anthrazit

PERLA³ 7

7020025	EAN 8053859012382	Neutra / Neutral / Neutre / Neutral
6920028	EAN 8053859012887	Maiolica Bianco / White Majolica / Céramique Blanc / Keramik Weiss
6920029	EAN 8053859012894	Maiolica Avorio / Ivory Majolica / Céramique Ivoire / Keramik Elfenbein
6920027	EAN 8053859012870	Maiolica Rosso / Red Majolica / Céramique Rouge / Keramik Rot
6920022	EAN 8053859012405	Metallo Bianco / White Steel / Acier Blanc / Metall Weiss
6920023	EAN 8053859012412	Metallo Rosso / Red Steel / Acier Rouge / Metall Rot
6920021	EAN 8053859012399	Metallo Antracite / Anthracite Steel / Acier Anthracite / Metall Anthrazit





KRISS³ 8,5



Una soluzione originale e senza compromessi, Kriss³ è una stufa a pellet dalle linee classiche che, grazie alla sua ampia scelta di rivestimenti metallici, si adatta facilmente ad ogni contesto.

An original solution and without compromise, Kriss³ is a pellet stove of classic design that easily fits in any context, thanks to its wide choice of metallic claddings.

Avec ses solutions originales et sans compromis, Kriss³ est un poêle à pellets aux lignes classiques qui, grâce à son large choix de revêtements métalliques, s'adapte facilement à tout contexte.

Eine originelle und kompromislose Lösung: Kriss³ ist ein Pelletofen mit klassischer Linie, der dank der großen Auswahl an Metallverkleidungen problemlos in jeden Raum passt.



KRISS³ 8,5

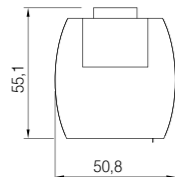

SOPRA - TOP - SUPÉRIEUR - OBER

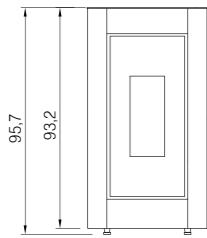

FRONTALE - FRONT - AVANT - VORDER

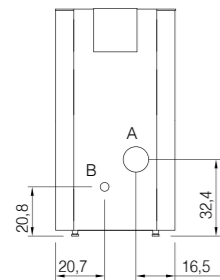

POSTERIORE - BACK - POSTÉRIEUR - HINTER

EUROPEAN STANDARDS

Art. 15A B-VG 2015
BlmSchV 2015
Regensburg
München
Stuttgart
Aachen



EN 14785:2006



ENERGY LABELLING



TECHNICAL DATA

8,6 kW



8,6 kW



2,4 kW



89,1%



92,9%



0,53 kg/h
2,01 kg/h



9 h
34 h



58 m³
206 m³



88 kg



L 80 cm
P 60 cm
H 114,3 cm



0,55 m³



42,13 dB
52,89 dB



Pellet
Ø 6 mm



18 kg



A Ø 80 mm



B Ø 60 mm



Metallo Bianco
White Steel
Acier Blanc
Metall Weiss



Metallo Light Bronze
Light Bronze Steel
Acier Light Bronze
Metall Light Bronze



Metallo Rosso
Red Steel
Acier Rouge
Metall Rot



Metallo Antracite
Anthracite Steel
Acier Anthracite
Metall Anthrazit

KRISS³ 8,5

7015036		EAN 8033123616614	Metallo Bianco / White Steel / Acier Blanc / Metall Weiss
7015034		EAN 8033123616591	Metallo Light Bronze / Light Bronze Steel / Acier Light Bronze / Metall Light Bronze
7015033		EAN 8033123616584	Metallo Rosso / Red Steel / Acier Rouge / Metall Rot
7015035		EAN 8033123616607	Metallo Antracite / Anthracite Steel / Acier Anthracite / Metall Anthrazit





CRISTAL³ 8,5

Cristal³ è una stufa a pellet funzionale e decorativa. Caratterizzata da un ottimo rapporto qualità prezzo è una soluzione alla portata di tutti.

Cristal³ s a functional and decorative pellet stove. Distinguished by excellent value for money, it is a solution for everyone.

Cristal³ est un poêle à pellets aussi fonctionnel que décoratif. Son excellent rapport qualité-prix en fait une solution à la portée de tous.

Cristal³ ist ein funktionaler, dekorativer Pelletofen. Dieser durch das ausgezeichnete Preis-Leistungs-Verhältnis gekennzeichnete Ofen ist eine für alle geeignete Lösung.



CRISTAL³ 8,5

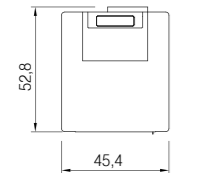

SOPRA - TOP - SUPÉRIEUR - OBER

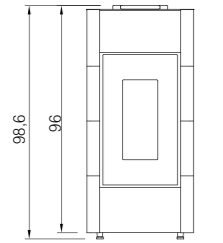

FRONTALE - FRONT - AVANT - VORDER

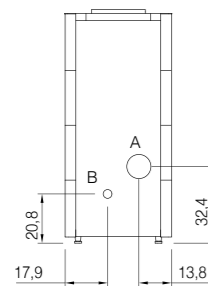

POSTERIORE - BACK - POSTÉRIEUR - HINTER



EUROPEAN STANDARDS

Art. 15A B-VG 2015
BlmSchV 2015
Regensburg
München
Stuttgart
Aachen



EN 14785:2006



ENERGY LABELLING



TECHNICAL DATA

8,6 kW



8,6 kW



2,4 kW



89,1%



92,9%



0,53 kg/h
2,01 kg/h



9 h
34 h



58 m³
206 m³



79 kg



L 80 cm
P 60 cm
H 114,3 cm



0,55 m³



42,13 dB
52,89 dB



Pellet
Ø 6 mm



18 kg



A Ø 80 mm



B Ø 60 mm



Metallo Bianco
White Steel
Acier Blanc
Metall Weiss



Metallo Rosso
Red Steel
Acier Rouge
Metall Rot



Metallo Antracite
Anthracite Steel
Acier Anthracite
Metall Anthrazit

CRISTAL³ 8,5

7018020		EAN 8053859010012	Metallo Bianco / White Steel / Acier Blanc / Metall Weiss
7018019		EAN 8053859010005	Metallo Rosso / Red Steel / Acier Rouge / Metall Rot
7018021		EAN 8053859010029	Metallo Antracite / Anthracite Steel / Acier Anthracite / Metall Anthrazit





ZEFIRO³

Zefiro³ si caratterizza per la sua ampia visione della fiamma e la presenza di un elegante vetro nero. Si integra perfettamente nei camini aperti esistenti e un kit di canalizzazione opzionale permette di scaldare più ambienti. Canalizzabile fino a 6 metri.

Zefiro³ is distinguished by its wide view of the flame and the elegant black glass. It integrates perfectly into existing open fireplaces and an optional ducting kit allows you to heat several rooms. Ductable upto 6 meters

Zefiro³ se caractérise par sa large vision de la flamme et la présence d'une vitre noire élégante. Il s'intègre parfaitement dans les cheminées ouvertes existantes et un kit de canalisation en option permet de chauffer plusieurs pièces. Canalisable jusqu'à 6 metres

Zefiro³ besticht durch seine großartige Sicht auf die Flamme und das elegante schwarze Glas. Der Ofen kann sehr gut in bereits vorhandene offene Kamine eingebaut werden, und ein optionaler Bausatz für die Kanalisierung ermöglicht es, mehrere Räume zu heizen. Kanalisierbar bis zu 6 Meter



ZEFIRO³

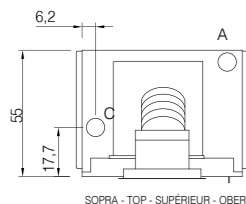

SOPRA - TOP - SUPERIEUR - OBER

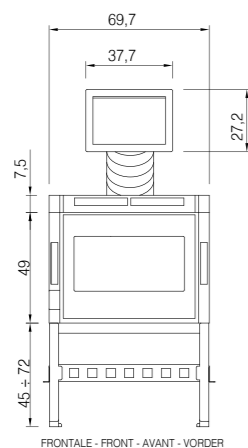

FRONTALE - FRONT - AVANT - VORDER

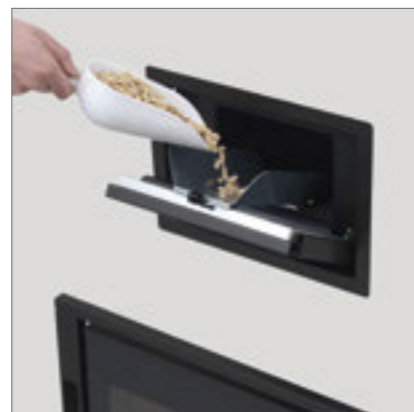

EUROPEAN STANDARDS

Art. 15A B-VG 2015
BlmSchV 2015
Regensburg
München
Stuttgart
Aachen



EN 14785:2006



ENERGY LABELLING



TECHNICAL DATA

9,3 kW

9,3 kW	2,7 kW	88,4%	94,2%
0,59 kg/h 2,17 kg/h	6,9 h 25 h	65 m ³ 223 m ³	94 kg
46,7 dB 60,8 dB	Pellet Ø 6 mm	15 kg	L 80 cm P 70 cm H 66 cm
		Ø 80 mm	Ø 60 mm
		Ø 80 mm	0,37 m ³



Possibilità di canalizzare 1 dei 2 motori
Option of ducting 1 of the 2 motors
Possibilité de canaliser 1 des 2 moteurs
Möglichkeit, einen der zwei Motoren zu kanalisieren



Kit gambe
Kit podium
Socle de support
Kit Sockel



Cassetto pellet
Pellet drawer
Tiroir à granules
Pellet-Lade



Botola pellet
Loading pellet door
Trappe de chargement des granulés
Pellet Ladeklappe



Cornice 792x561 mm
Frame 792x561 mm
Cadre 792x561 mm
Struktur 792x561 mm



Kit canalizzazione
Ducting kit
Kit conduits d'aération
Kit für Kanalisierung

ZEFIRO³

7018023 EAN 8053859010050 Vetro Nero / Black Glass / Verre Noir / Glas Schwartz

OPTIONAL

5020015	EAN 8053859012832	Kit gambe / Kit podium / Socle de support / Kit Sockel
5018001	EAN 8053859010258	Cassetto pellet / Pellet drawer / Tiroir à granules / Pellet-Lade
5018002	EAN 8053859010265	Botola pellet / Loading pellet door / Trappe de chargement des granulés / Pellet Ladeklappe
5018006	EAN 8053859010302	Cornice / Frame / Cadre / Struktur / 792x561 mm
5018007	EAN 8053859010319	Cornice (cassetto) / Frame (drawer) / Cadre (tiroir) / Struktur (Lade) / 792x617 mm
5018005	EAN 8053859010296	Kit canalizzazione / Ducting kit / Kit conduits d'aération / Kit für Kanalisierung





FRAME³

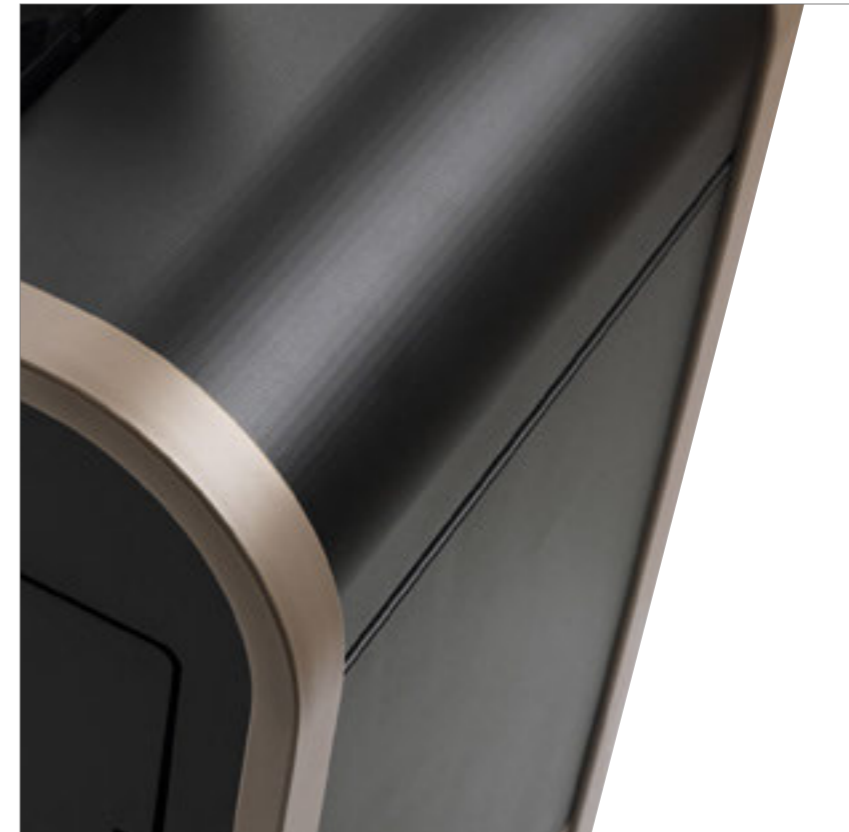

Uno stile raffinato e metropolitano, un'ampia visione della fiamma e piedini eleganti. Frame³ si inserisce armoniosamente sia in ambienti contemporanei che rustici e permette di scaldare più stanze grazie al suo kit di canalizzazione opzionale. Disponibile anche in versione UP.

A refined and metropolitan style, a wide view of the flame and elegant feet. Frame3 fits harmoniously both in contemporary and rustic environments and allows you to heat several rooms thanks to its optional ducting kit. Also available in the UP version.

Un style raffiné et métropolitain, une large vision de la flamme et des pieds élégants. Frame3 s'insère de manière harmonieuse aussi bien dans les décors contemporains que rustiques et permet de chauffer plusieurs pièces grâce à son kit de canalisation en option. Également disponible en version UP.

Ein Stil voller Großstadt-Raffinesse, eine gute Sicht auf die Flammen und elegante Füße. Frame3 passt bestens in zeitgenössisch, aber auch rustikal eingerichtete Räume und ermöglicht es dank dem als Optional lieferbaren Bausatz für die Kanalisierung, mehrere Räume zu heizen. Auch in der Version UP verfügbar.





FRAME³ UP

NEW

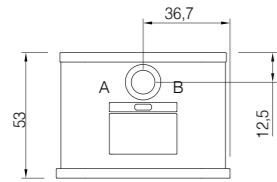

SOPRA - TOP - SUPÉRIEUR - OBER

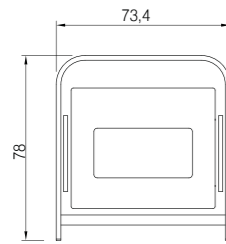

FRONTALE - FRONT - AVANT - VORDER

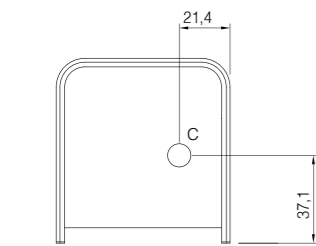

POSTERIORE - BACK - POSTÉRIEUR - HINTER



EUROPEAN STANDARDS

Art. 15A B-VG 2015
BImSchV 2015
Regensburg
München
Stuttgart
Aachen



EN 14785:2006



ENERGY LABELLING



TECHNICAL DATA

9,3 kW



9,3 kW



2,7 kW



89%



93,9%



0,59 kg/h
2,18 kg/h



6,9 h
25 h



65 m³
223 m³



105 kg



L 80 cm
P 70 cm
H 95 cm



0,53 m³



46,7 dB
60,8 dB



Pellet
Ø 6 mm



15 kg



Ø 80 mm



Ø 130 mm



Ø 80 mm



Possibilità di canalizzare 1 dei 2 motori
Option of ducting 1 of the 2 motors
Possibilité de canaliser 1 des 2 moteurs
Möglichkeit, einen der zwei Motoren zu kanalisieren



Metallo Light Bronze
Light Bronze Steel
Acier Light Bronze
Metall Light Bronze



Kit canalizzazione
Ducting kit
Kit conduits d'aération
Kit für Kanalisierung



Kit scivolo caricamento pellet
Pellet loading chute kit
Kit goulotte chargement pellets
Kit Rutsche für Pelletzufuhr



Metallo Antracite
Anthracite Steel
Acier Anthracite
Metall Anthrazit



Metallo Nero
Black Steel
Acier Noir
Metall Schwarz

FRAME³ UP

7020004		EAN 8053859012740	Metallo Light Bronze / Light Bronze Steel / Acier Light Bronze / Metall Light Bronze
7020005		EAN 8053859012733	Metallo Antracite / Anthracite Steel / Acier Anthracite / Metall Anthrazit
7020006		EAN 8053859012726	Metallo Nero / Black Steel / Acier Noir / Metall Schwarz

OPTIONAL

5018009	EAN 8053859010333	Kit canalizzazione / Ducting kit / Kit conduits d'aération / Kit für Kanalisierung
5018013	EAN 8053859010494	Kit scivolo caricamento pellet / Pellet loading chute kit / Kit goulotte chargement pellets / Kit Rutsche für Pelletzufuhr





FRAME³

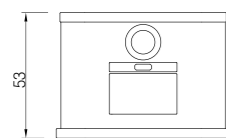

SOPRA - TOP - SUPÉRIEUR - OBER

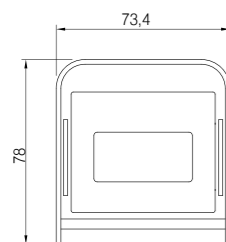

FRONTALE - FRONT - AVANT - VORDER

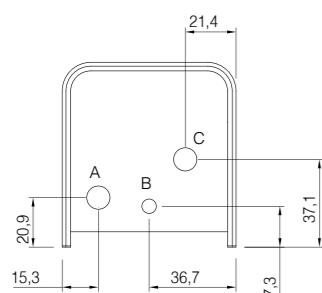

POSTERIORE - BACK - POSTÉRIEUR - HINTER



EUROPEAN STANDARDS

Art. 15A B-VG 2015
BlmSchV 2015
Regensburg
München
Stuttgart
Aachen



EN 14785:2006



ENERGY LABELLING



TECHNICAL DATA

9,3 kW



9,3 kW



2,7 kW



89%



93,9%



0,59 kg/h
2,18 kg/h



6,9 h
25 h



65 m³
223 m³



105 kg



L 80 cm
P 70 cm
H 95 cm



0,53 m³



46,7 dB
60,8 dB



Pellet
Ø 6 mm



15 kg



A Ø 80 mm



B Ø 60 mm



C Ø 80 mm



Possibilità di canalizzare 1 dei 2 motori
Option of ducting 1 of the 2 motors
Possibilité de canaliser 1 des 2 moteurs
Möglichkeit, einen der zwei Motoren zu kanalisieren



Metallo Light Bronze
Light Bronze Steel
Acier Light Bronze
Metall Light Bronze



Kit canalizzazione
Ducting kit
Kit conduits d'aération
Kit für Kanalisierung



Kit scivolo caricamento pellet
Pellet loading chute kit
Kit goulotte chargement pellets
Kit Rutsche für Pelletzufuhr



Metallo Antracite
Anthracite Steel
Acier Anthracite
Metall Anthrazit



Metallo Nero
Black Steel
Acier Noir
Metall Schwarz

FRAME³

7018024		EAN 8053859010067	Metallo Light Bronze / Light Bronze Steel / Acier Light Bronze / Metall Light Bronze
7018025		EAN 8053859010074	Metallo Antracite / Anthracite Steel / Acier Anthracite / Metall Anthrazit
7018034		EAN 8053859010500	Metallo Nero / Black Steel / Acier Noir / Metall Schwarz

OPTIONAL

5018009	EAN 8053859010333	Kit canalizzazione / Ducting kit / Kit conduits d'aération / Kit für Kanalisierung
5018013	EAN 8053859010494	Kit scivolo caricamento pellet / Pellet loading chute kit / Kit goulotte chargement pellets / Kit Rutsche für Pelletzufuhr





SHELL³



Linee morbide e materiale high tech per una stufa dal design unico. Quando la stufa è spenta il suo vetro Magic Glass si oscura trasformandola in un vero oggetto di arredamento. Disponibile con uscita scarico fumi posteriore oppure superiore.

Soft lines and high tech material for a stove with a unique design. When the stove is off, its Magic Glass darkens, turning it into an actual furnishing element. Available with a rear or top smoke exhaust outlet.

Lignes douces et matériau high tech pour un poêle au design unique. Lorsque le poêle est éteint sa vitre Magic Glass s'obscurcit, le transformant en un véritable objet de décoration. Disponible avec la sortie d'évacuation des fumées postérieure ou supérieure.

Weich fließende Linien und Hightech-Material für einen Ofen mit einzigartigem Design. Wenn der Ofen ausgeschaltet ist, wird seine Glasscheibe Magic Glass dunkel und verwandelt ihn in einen echten Einrichtungsgegenstand. Mit Ausgang des Rauchgasauslasses hinten oder oben lieferbar.





SHELL³

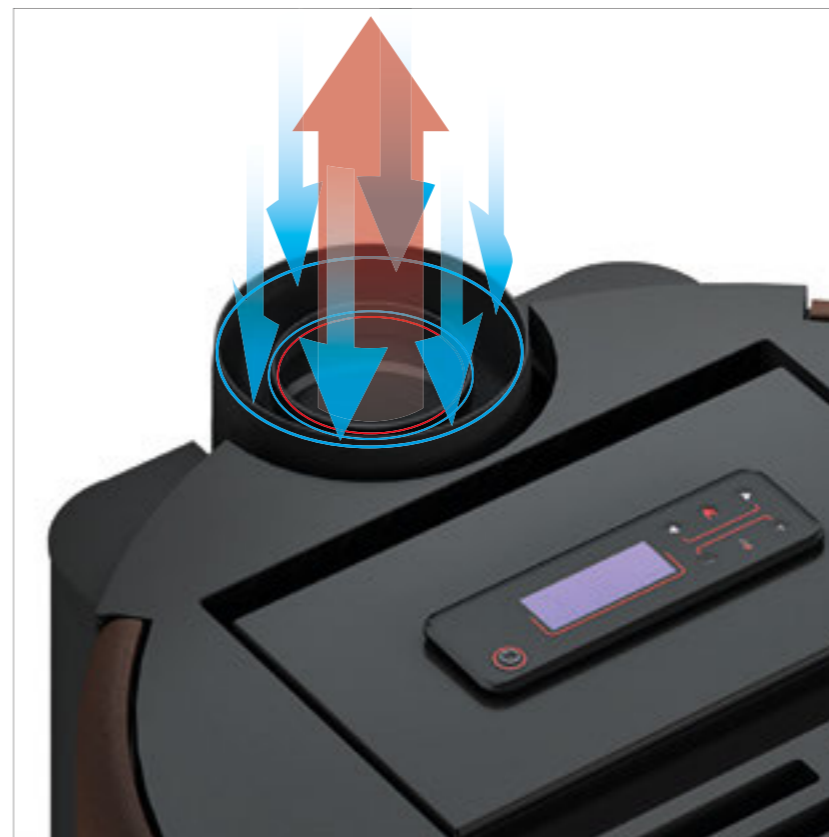

Stufa a pellet stagna con uscita UP coassiale.

Sealed pellet stove with coaxial UP outlet.

Poêle à pellets étanche avec sortie UP coaxiale.

Gasdichter Pelletofen mit koaxialem UP-Ausgang.



Particolarmente indicata per un'installazione ad angolo.

Particularly suited for corner installation.

Particulièrement indiqué pour une installation d'angle.

Besonders für die Eckinstallation geeignet.



SHELL³ UP

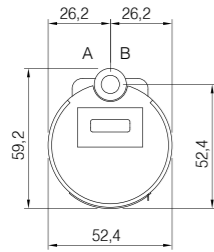

SOPRA - TOP - SUPÉRIEUR - OBER

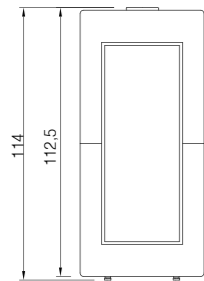

FRONTALE - FRONT - AVANT - VORDER



EUROPEAN STANDARDS

Art. 15A B-VG 2015
 BImSchV 2015
 Flensburg
 München
 Stuttgart
 Aachen



EN 14785:2006



ENERGY LABELLING



TECHNICAL DATA

9,1 kW



9,1 kW



2,4 kW



88,7%



92,9%



0,53 kg/h
2,12 kg/h



8 h
32,1 h



58 m³
218 m³



88 kg



L 80 cm
P 70 cm
H 131,4 cm



0,74 m³



42,13 dB
52,89 dB



Pellet
Ø 6 mm



17 kg



Ø 80 mm



Ø 130 mm



Metallo Bianco
White Steel
Acier Blanc
Metall Weiss



Metallo Titanium
Titanium Steel
Acier Titanium
Metall Titanium



Metallo Dark Bronze
Dark Bronze Steel
Acier Dark Bronze
Metall Dark Bronze



Metallo Antracite
Anthracite Steel
Acier Anthracite
Metall Anthrazit

SHELL³ UP

7019019		EAN 8053859010784	Metallo Bianco / White Steel / Acier Blanc / Metall Weiss
7019021		EAN 8053859010807	Metallo Titanium / Titanium Steel / Acier Titanium / Metall Titanium
7019020		EAN 8053859010791	Metallo Dark Bronze / Dark Bronze Steel / Acier Dark Bronze / Metall Dark Bronze
7019018		EAN 8053859010777	Metallo Antracite / Anthracite Steel / Acier Anthracite / Metall Anthrazit





SHELL³ PS

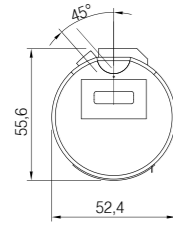

SOPRA - TOP - SUPÉRIEUR - OBER

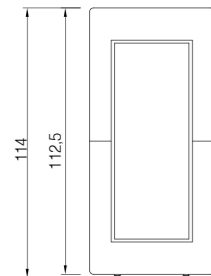

FRONTALE - FRONT - AVANT - VORDER

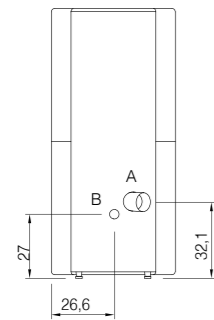

POSTERIORE - BACK - POSTÉRIEUR - HINTER

EUROPEAN STANDARDS

Art. 15A B-VG 2015
 BImSchV 2015
 Flgenschub
 München
 Stuttgart
 Aachen



EN 14785:2006



ENERGY LABELLING



TECHNICAL DATA

9,1 kW



9,1 kW



2,4 kW



88,7%



92,9%



0,53 kg/h
2,12 kg/h



8 h
32,1 h



58 m³
218 m³



85,3 kg



L 80cm
P 70 cm
H 131,4 cm



0,74 m³



42,13 dB
52,89 dB



Pellet
Ø 6 mm



17 kg



A Ø 80 mm



B Ø 60 mm



Metallo Bianco
White Steel
Acier Blanc
Metall Weiss



Metallo Titanium
Titanium Steel
Acier Titanium
Metall Titanium



Metallo Dark Bronze
Dark Bronze Steel
Acier Dark Bronze
Metall Dark Bronze



Metallo Antracite
Anthracite Steel
Acier Anthracite
Metall Anthrazit

SHELL³ PS

7019068		EAN 8053859011613	Metallo Bianco / White Steel / Acier Blanc / Metall Weiss
7019070		EAN 8053859011637	Metallo Titanium / Titanium Steel / Acier Titanium / Metall Titanium
7019069		EAN 8053859011620	Metallo Dark Bronze / Dark Bronze Steel / Acier Dark Bronze / Metall Dark Bronze
7019067		EAN 8053859011606	Metallo Antracite / Anthracite Steel / Acier Anthracite / Metall Anthrazit





SFERA³

Stufa a pellet che si distingue per un design semplice ed essenziale e che può essere posizionata anche ad angolo. Grazie alla sua forma cilindrica rende il fuoco il vero protagonista.

Un poêle à pellets qui se distingue par un design simple et essentiel, pouvant être placé également dans un coin. Grâce à sa forme cylindrique, le feu devient un véritable protagoniste.

A pellet stove that stands out for its simple and essential design and can also be placed at a corner. Thanks to its cylindrical shape it makes the fire the actual protagonist.

Ein Pelletofen, der durch das einfache und essentielle Design glänzt und auch in einer Ecke aufgestellt werden kann. Dank seiner Zylinderform wird hier das Feuer zum eigentlichen Protagonisten.



SFERA³

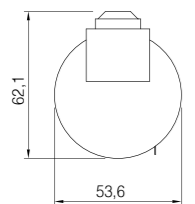

SOPRA - TOP - SUPÉRIEUR - OBER

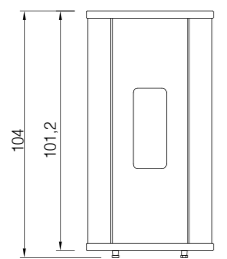

FRONTALE - FRONT - AVANT - VORDER

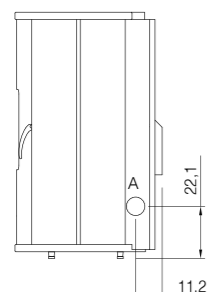

LATERALE - SIDE - LATÉRAL - SEITLICH

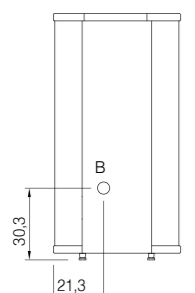

POSTERIORE - BACK - POSTÉRIEUR - HINTER

EUROPEAN STANDARDS

Art. 15A B-VG 2015
BlmSchV 2015
Regensburg
München
Stuttgart
Aachen



EN 14785:2006



ENERGY LABELLING



TECHNICAL DATA

11 kW



11 kW



3,3 kW



91%



93,5%



0,73 kg/h
2,6 kg/h



8,5 h
30 h



79 m³
264 m³



104,2 kg



L 80 cm
P 70 cm
H 124,5 cm



0,70 m³



46,7 dB
60,8 dB



Pellet
Ø 6 mm



22 kg



A Ø 80 mm



B Ø 60 mm



Kit opzionale
Optional kit
Kit optionnel
Kit optional



Metallo Bianco
White Steel
Acier Blanc
Metall Weiss



Metallo Titanium
Titanium Steel
Acier Titanium
Metall Titanium



Kit scarico sup.
Upper exhaust kit
Kit sortie fumée sup.
Kit Abgasstutzen oben



Metallo Rosso
Red Steel
Acier Rouge
Metall Rot



Metallo Dark Bronze
Dark Bronze Steel
Acier Dark Bronze
Metall Dark Bronze



Metallo Antracite
Anthracite Steel
Acier Anthracite
Metall Anthrazit

SFERA³

7019040	EAN 8053859011309	Neutra / Neutral / Neutre / Neutral
6914017	EAN 8033123614917	Metallo Bianco / White Steel / Acier Blanc / Metall Weiss
6919010	EAN 8053859011248	Metallo Titanium / Titanium Steel / Acier Titanium / Metall Titanium
6914016	EAN 8033123614900	Metallo Rosso / Red Steel / Acier Rouge / Metall Rot
6919014	EAN 8053859011286	Metallo Dark Bronze / Dark Bronze Steel / Acier Dark Bronze / Metall Dark Bronze
6914019	EAN 8033123614931	Metallo Antracite / Anthracite Steel / Acier Anthracite / Metall Anthrazit

OPTIONAL

5019004	EAN 8053859010975	Kit scarico sup. / Upper exhaust kit / Kit sortie fumée sup. / Kit Abgasstutzen oben
---------	-------------------	--





PRINCE³



Uno dei bestseller di Cadel, questa stufa si caratterizza per il suo design semplice, curato nei dettagli, un ampio serbatoio e una potenza importante accessibile ad ogni budget.

One of Cadel's bestsellers - this stove is distinguished by its simple design, attention to detail, a large tank and significant power that suits every budget.

L'un des best-sellers de Cadel, ce poêle se caractérise par son design simple, soigné dans les moindres détails, par un large réservoir et une puissance importante à la portée de tous les budgets.

Dieser Ofen, einer der Bestseller von Cadel, besticht durch das einfache, bis ins letzte Detail durchdachte Design, den großen Behälter und eine beträchtliche Leistung und ist für jedes Budget erschwinglich.



PRINCE³

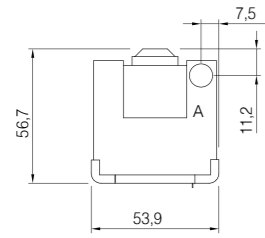

SOPRA - TOP - SUPÉRIEUR - OBER

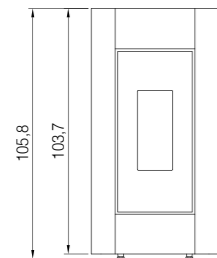

FRONTALE - FRONT - AVANT - VORDER

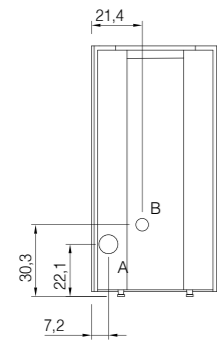

POSTERIORE - BACK - POSTÉRIEUR - HINTER



EUROPEAN STANDARDS

Art. 15A B-VG 2015
BImSchV 2015
Regensburg
München
Stuttgart
Aachen



EN 14785:2006



TECHNICAL DATA

11 kW

11 kW	3,3 kW	91%	93,5%
0,73 kg/h 2,6 kg/h	8,5 h 30 h	79 m ³ 264 m ³	108,7 kg
46,7 dB 60,8 dB	Pellet Ø 6 mm	22 kg	A Ø 80 mm B Ø 60 mm
		L 80 cm P 70 cm H 124,5 cm	0,70 m ³



Metallo Bianco
White Steel
Acier Blanc
Metall Weiss



Metallo Light Bronze
Light Bronze Steel
Acier Light Bronze
Metall Light Bronze



Metallo Titanium
Titanium Steel
Acier Titanium
Metall Titanium



Metallo Rosso
Red Steel
Acier Rouge
Metall Rot



Metallo Antracite
Anthracite Steel
Acier Anthracite
Metall Anthrazit

PRINCE³

7019042	EAN 8053859011323	Neutra / Neutral / Neutre / Neutral
6915031	EAN 8033123616447	Metallo Bianco / White Steel / Acier Blanc / Metall Weiss
6914043	EAN 8033123615884	Metallo Light Bronze / Light Bronze Steel / Acier Light Bronze / Metall Light Bronze
6919011	EAN 8053859011255	Metallo Titanium / Titanium Steel / Acier Titanium / Metall Titanium
6915032	EAN 8033123616454	Metallo Rosso / Red Steel / Acier Rouge / Metall Rot
6915030	EAN 8033123616430	Metallo Antracite / Anthracite Steel / Acier Anthracite / Metall Anthrazit





PELLET AIR PLUS

Per riscaldare più ambienti della casa in modo economico e pratico la stufa a pellet canalizzabile Air Plus di Cadel è lo strumento ideale. Grazie al sistema di canalizzazione è possibile distribuire il calore rapidamente e in modo omogeneo anche in altre stanze. **Tutti i modelli di stufe Pellet Air Plus sono certificati Classe Energetica A+, 4 stelle Aria Pulita, 7 stelle Flamme Verte e sono riconosciuti come idonei a ricevere il rimborso Conto Termico.**

A Cadel Air Plus ductable pellet stove is the ideal tool to heat up several rooms in the house in a cost-effective and convenient way. Thanks to its ducting, you can distribute heat quickly and evenly in other rooms as well.

All Pellet Air Plus Stove models are conform with the EcoDesign 2022 directives.

Pour chauffer plusieurs pièces de la maison de manière économique et pratique, le poêle à pellets canalisable Air Plus de Cadel est l'instrument idéal. Grâce au système de canalisation, il est possible de distribuer la chaleur rapidement et de façon homogène dans d'autres pièces aussi.

Tous les modèles de poeles Pellet Air plus sont certifiés 7 étoiles Flamme Vert et sont reconnus comme éligibles au credit d'impot. En outre, un an après leur introduction, ils sont référencés CSTB.

Der kanalierbare Pelletofen Air Plus von Cadel ist die ideale Lösung, um auf sparsame und praktische Weise mehrere Wohnräume zu erwärmen. Die Kanalisierung ermöglicht es, die Wärme rasch und gleichmäßig auch auf andere Räume zu verteilen.

Alle Pelletofen Modelle der Linie Air Plus sind Bimsch 2015 (Regensburg, Munchen, Stuttgart, Aachen) und Klima Energiefonds zertifiziert.



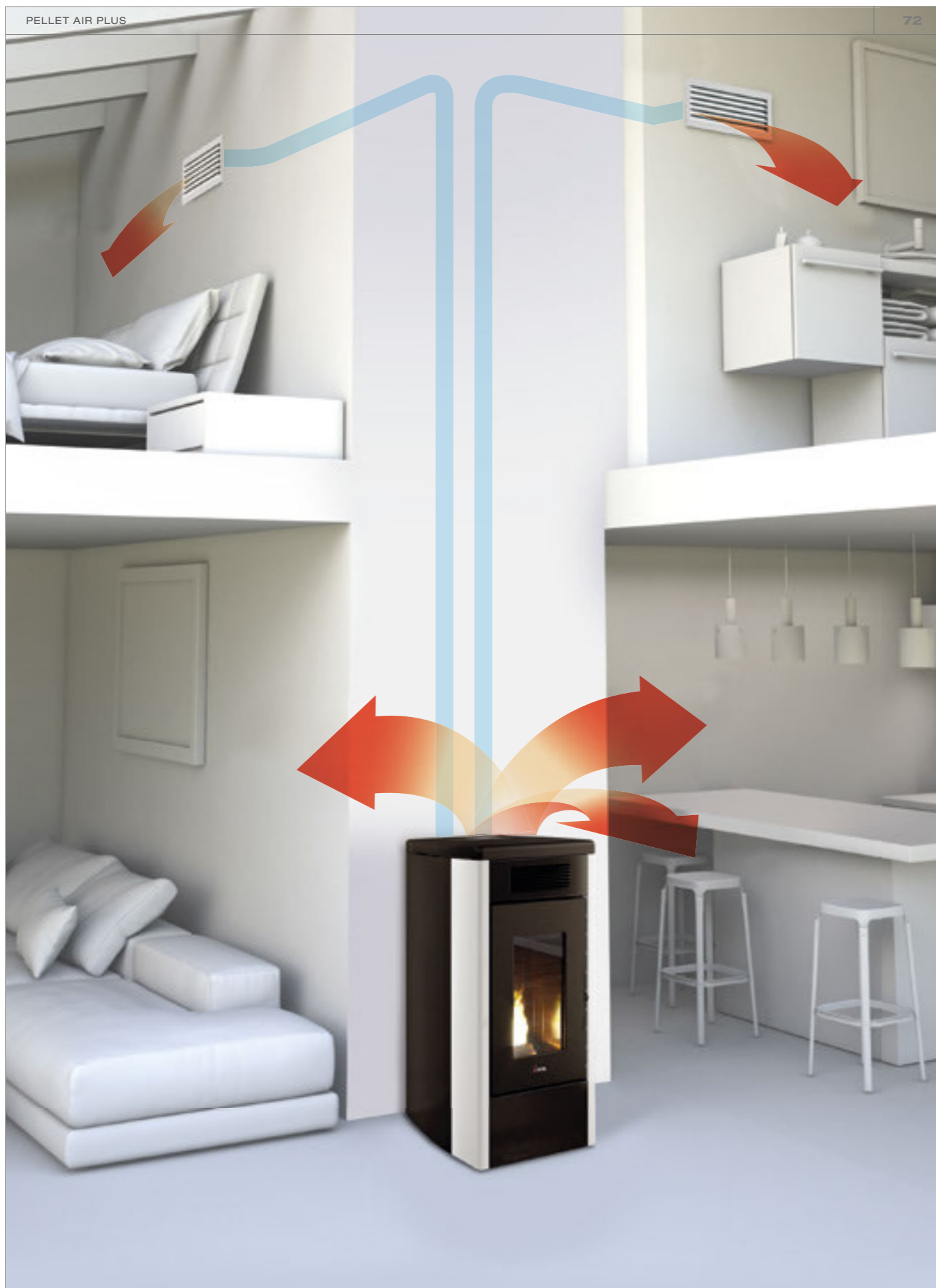

IL CALORE SI DIFFONDE IN PIÙ AMBIENTI

Quando si vogliono riscaldare più ambienti con un'unica sorgente di calore, la stufa a pellet AIR PLUS è lo strumento ideale.

Grazie al sistema canalizzabile di tubi che dall'impianto trasportano l'aria calda in altri ambienti, è possibile distribuire in più stanze della stessa casa il calore in modo omogeneo.

La spinta dell'aria riscaldata viene data dai ventilatori presenti all'interno della macchina.

HEAT IS CONVEYED INTO SEVERAL ROOMS

When you want to heat several rooms with a single heat source, a ductable pellet stove is the ideal answer.

Thanks to the ductable system of pipes that convey the hot air from the system into other environments, the heat can be evenly distributed in several rooms of the same house.

The hot air is pushed by the fans inside the machine.

LA CHALEUR DIFFUSÉE DANS PLUSIEURS LOCAUX

Quand il est nécessaire de chauffer plusieurs pièces à la fois le poêle à granulés canalisable est l'outil idéale.

Grace au système de canalisation avec des tuyaux qui transportent l'air chaud dans différentes pièces il est possible de diffuser la chaleur dans plusieurs locaux de façon homogène.

La propulsion de l'air est assurée par les ventilateurs de type centrifuge présents à l'intérieur de l'appareil.

DIE WÄRME BREITET SICH AUF MEHRERE RÄUME AUS

Wenn mehrere Räume von einer einzigen Hitzequelle aus geheizt werden sollen, ist der Pelletofen mit kanalisierbarer Luft die ideale Lösung.

Die warme Luft wird durch die Rohre des Kanalisationssystems in andere Räume geleitet, die gleichmäßig erwärmt werden.

Die Einblasung der warmen Luft erfolgt durch die in der Maschine vorhandenen Ventilatoren.



TILE³ PLUS

Tile³ Plus, grazie ai suoi 29 centimetri di profondità, è la risposta per chi cerca una stufa potente ed elegante da inserire nei piccoli spazi. Versatile, lo scarico fumi può essere superiore, posteriore o laterale. Canalizzabile fino a 6 metri.

Thanks to its 29 centimetre depth, Tile³ Plus is the solution for those looking for a powerful and smart stove to fit into small spaces. Versatile: the smoke outlet can be at the top, rear or side. Ductable up to 6 meters.

Grâce à ses 29 centimètres de profondeur, Tile³ Plus est la réponse pour ceux qui cherchent un poêle puissant et élégant à insérer dans les petits espaces. Polyvalente, l'évacuation des fumées peut être supérieure, postérieure et latérale. Canalisable jusqu'à 6 mètres.

Tile³ Plus ist dank der nur 29 Zentimeter Tiefe die ideale Lösung, wenn ein leistungsstarker und eleganter Ofen auf geringem Raum installiert werden soll. Der Rauchgasabzug kann bei diesem vielseitigen Ofen oben, hinten oder auf der Seite sein. Kanalisierbar bis zu 6 Meter.



TILE³ PLUS

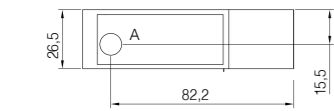

SOPRA - TOP - SUPÉRIEUR - OBER

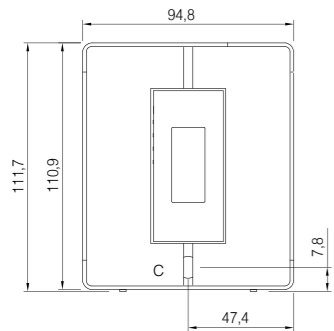

FRONTALE - FRONT - AVANT - VORDER

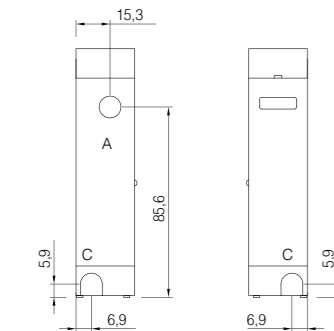

LATERALE - SIDE - LATÉRAL - SEITLICH

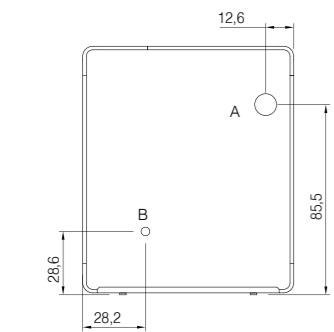

POSTERIORE - BACK - POSTÉRIEUR - HINTER



EUROPEAN STANDARDS

Art. 15A B-VG 2015
BImSchV 2015
Regensburg
München
Stuttgart
Aachen



EN 14785:2006



ENERGY LABELLING



TECHNICAL DATA

10 kW

10 kW	3 kW	91%	94,5%	L 120 cm P 100 cm H 54,6 cm	0,66 m ³
0,66 kg/h 2,24 kg/h	8 h 27,3 h	72 m ³ 240 m ³	130 kg	Ø 80 mm	Ø 60 mm
41,6 dB 63,0 dB	Pellet Ø 6 mm	18 kg	Ø 80 mm	Ø 60 mm	Ø 80 mm



Metallo Bianco
White Steel
Acier Blanc
Metall Weiss



Metallo Light Bronze
Light Bronze Steel
Acier Light Bronze
Metall Light Bronze



Metallo Titanium
Titanium Steel
Acier Titanium
Metall Titanium



Metallo Rosso
Red Steel
Acier Rouge
Metall Rot



Metallo Antracite
Anthracite Steel
Acier Anthracite
Metall Anthrazit

TILE³ PLUS

7018002	EAN 8053859010036	Neutra / Neutral / Neutre / Neutral
6918017	EAN 8053859010227	Metallo Bianco / White Steel / Acier Blanc / Metall Weiss
6918013	EAN 8053859010180	Metallo Light Bronze / Light Bronze Steel / Acier Light Bronze / Metall Light Bronze
6919012	EAN 8053859011262	Metallo Titanium / Titanium Steel / Acier Titanium / Metall Titanium
6918016	EAN 8053859010210	Metallo Rosso / Red Steel / Acier Rouge / Metall Rot
6918014	EAN 8053859010197	Metallo Antracite / Anthracite Steel / Acier Anthracite / Metall Anthrazit





WALL³ PLUS

Un design particolare, una profondità ristretta e un'elevata potenza caratterizzano la stufa a pellet Wall³ Plus, rendendola perfetta per piccoli spazi, come corridoi, e per scaldare altri ambienti della casa.

A special design, restricted depth and high power distinguish the Wall³ Plus pellet stove, making it perfect for small spaces, such as corridors, and for heating several rooms in the home.

Un design particulier, une profondeur réduite et une puissance élevée caractérisent le poêle à pellets Wall³ Plus, en le rendant parfait pour les petits espaces, comme les couloirs, et pour chauffer les autres pièces de la maison.

Ein ganz besonderes Design, eine geringe Tiefe und hohe Leistung, das sind die Merkmale des Pelletofens Wall³ Plus, der ideal ist für die Installation in geringen Platzverhältnissen, wie zum Beispiel in Korridoren, von wo aus auch andere Räume des Hauses geheizt werden können.

WALL³ PLUS

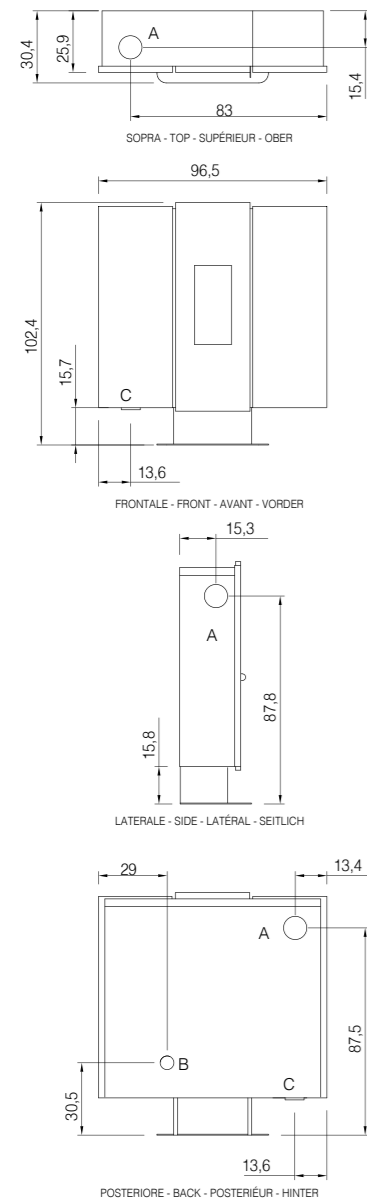

EUROPEAN STANDARDS

Art. 15A B-VG 2015
BlmSchV 2015
Regensburg
München
Stuttgart
Aachen



EN 14785:2006



ENERGY LABELLING



TECHNICAL DATA

10 kW

10 kW	3 kW	91%	94,5%
0,66 kg/h 2,24 kg/h	8 h 27,3 h	72 m ³ 240 m ³	103 kg
41,6 dB 63,0 dB	Pellet Ø 6 mm	18 kg	L 120 cm P 100 cm H 54,6 cm
		A Ø 80 mm	B Ø 60 mm
		C Ø 80 mm	0,66 m ³



Metallo Bianco
White Steel
Acier Blanc
Metall Weiss



Metallo Rosso
Red Steel
Acier Rouge
Metall Rot

WALL³ PLUS

7017032	EAN 8033123618311	Neutra / Neutral / Neutre / Neutral
6913025	EAN 8033123612876	Metallo Bianco / White Steel / Acier Blanc / Metall Weiss
6913024	EAN 8033123612883	Metallo Rosso / Red Steel / Acier Rouge / Metall Rot





SFERA³ PLUS

Stufa a pellet dal design essenziale dalla forma cilindrica che permette anche un'eventuale installazione ad angolo. Tramite la canalizzazione dell'aria calda può riscaldare contemporaneamente più stanze dell'abitazione.

A pellet stove with a basic design and a cylindrical shape that also allows it to be installed in a corner. By channelling the hot air it can heat several rooms in the home simultaneously.

Un poêle à pellets au design essentiel et à la forme cylindrique qui permet également une éventuelle installation d'angle. La canalisation de l'air chaud permet de chauffer simultanément plusieurs pièces de la maison.

Ein zylinderförmiger Pelletofen mit essentiell Design, der auch die Installation in einer Ecke ermöglicht. Dank der Kanalisierung der heißen Luft kann er gleichzeitig mehrere Räume im Haus heizen.



SFERA³ PLUS

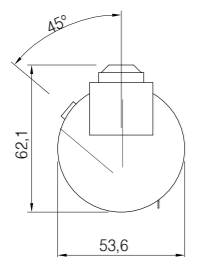

SOPRA - TOP - SUPERIEUR - OBER

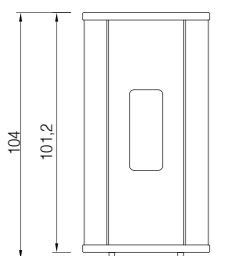

FRONTALE - FRONT - AVANT - VORDER

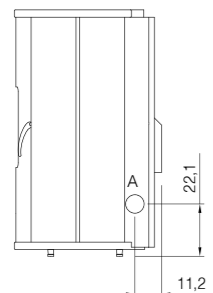

LATERALE - SIDE - LATÉRAL - SEITLICH

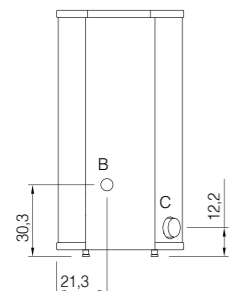

POSTERIORE - BACK - POSTÉRIEUR - HINTER

EUROPEAN STANDARDS

Art. 15A B-VG 2015
BImSchV 2015
Regensburg
München
Stuttgart
Aachen



EN 14785:2006



ENERGY LABELLING



TECHNICAL DATA

11 kW



11 kW



3,3 kW



89%



93,5%



0,73 kg/h
2,6 kg/h



8,5 h
30 h



79 m³
264 m³



104,2 kg



L 80 cm
P 70 cm
H 124,5 cm



0,70 m³



46,7 dB
60,8 dB



Pellet
Ø 6 mm



22 kg



A Ø 80 mm



B Ø 60 mm



C Ø 80 mm



Kit opzionale
Optional kit
Kit optionnel
Kit optional



Metallo Bianco
White Steel
Acier Blanc
Metall Weiss



Metallo Titanium
Titanium Steel
Acier Titanium
Metall Titanium



Kit scarico sup.
Upper exhaust kit
Kit sortie fumée sup.
Kit Abgasstutzen oben



Metallo Rosso
Red Steel
Acier Rouge
Metall Rot



Metallo Dark Bronze
Dark Bronze Steel
Acier Dark Bronze
Metall Dark Bronze



Metallo Antracite
Anthracite Steel
Acier Anthracite
Metall Anthrazit

SFERA³ PLUS

7019041	EAN 8053859011316	Neutra / Neutral / Neutre / Neutral
6914017	EAN 8033123614917	Metallo Bianco / White Steel / Acier Blanc / Metall Weiss
6919010	EAN 8053859011248	Metallo Titanium / Titanium Steel / Acier Titanium / Metall Titanium
6914016	EAN 8033123614900	Metallo Rosso / Red Steel / Acier Rouge / Metall Rot
6919014	EAN 8053859011286	Metallo Dark Bronze / Dark Bronze Steel / Acier Dark Bronze / Metall Dark Bronze
6914019	EAN 8033123614931	Metallo Antracite / Anthracite Steel / Acier Anthracite / Metall Anthrazit

OPTIONAL

5019004	EAN 8053859010975	Kit scarico sup. / Upper exhaust kit / Kit sortie fumée sup. / Kit Abgasstutzen oben
---------	-------------------	--





PRINCE³ PLUS

Un design semplice e curato e un serbatoio capiente, abbinati a una potenza elevata ed un prezzo accessibile, hanno reso la Prince³ Plus un bestseller tra le canalizzate.

Prince³ Plus is one of the bestselling ducted stoves thanks to its simple and curated design and large tank, combined with high power and an affordable price.

Un design simple et soigné et un grand réservoir, associés à une puissance élevée et un prix accessible, ont fait de Prince³ Plus un best-seller parmi les poêles canalisés.

Das einfache und gut durchdachte Design, der große Behälter und die beachtliche Leistung, kombiniert mit einem durchaus erschwinglichen Preis, haben Prince³ Plus zu einem Bestseller bei den kanalisierten Öfen gemacht.



PRINCE³ PLUS

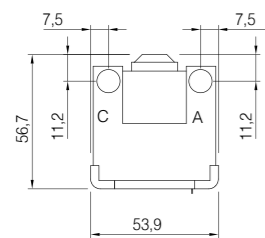

SOPRA - TOP - SUPERIEUR - OBER

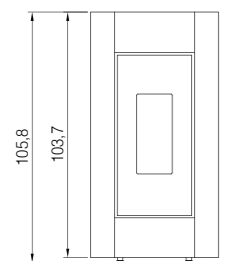

FRONTALE - FRONT - AVANT - VORDER

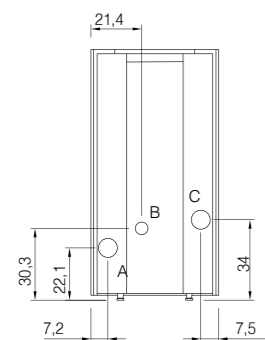

POSTERIORE - BACK - POSTERIEUR - HINTER



EUROPEAN STANDARDS

Art. 15A B-VG 2015
BImSchV 2015
Regensburg
München
Stuttgart
Aachen



EN 14785:2006



ENERGY LABELLING



TECHNICAL DATA

11 kW

11 kW	3,3 kW	89%	93,5%
0,73 kg/h 2,6 kg/h	8,5 h 30 h	79 m ³ 264 m ³	108,7 kg
46,7 dB 60,8 dB	Pellet Ø 6 mm	22 kg	L 80 cm P 70 cm H 124,5 cm
		Ø 80 mm	Ø 60 mm
		Ø 80 mm	0,70 m ³



Metallo Bianco
White Steel
Acier Blanc
Metall Weiss



Metallo Light Bronze
Light Bronze Steel
Acier Light Bronze
Metall Light Bronze



Metallo Titanium
Titanium Steel
Acier Titanium
Metall Titanium



Metallo Rosso
Red Steel
Acier Rouge
Metall Rot



Metallo Antracite
Anthracite Steel
Acier Anthracite
Metall Anthrazit

PRINCE³ PLUS

7019043	EAN 8053859011330	Neutra / Neutral / Neutre / Neutral
6915031	EAN 8033123616447	Metallo Bianco / White Steel / Acier Blanc / Metall Weiss
6914043	EAN 8033123615884	Metallo Light Bronze / Light Bronze Steel / Acier Light Bronze / Metall Light Bronze
6919011	EAN 8053859011255	Metallo Titanium / Titanium Steel / Acier Titanium / Metall Titanium
6915032	EAN 8033123616454	Metallo Rosso / Red Steel / Acier Rouge / Metall Rot
6915030	EAN 8033123616430	Metallo Antracite / Anthracite Steel / Acier Anthracite / Metall Anthrazit





ATENA³ PLUS 12 / 14

NEW



Stufa a pellet stagna con doppia canalizzazione a gestione indipendente. Dotata di Wi-Fi integrato per il controllo da remoto, braciere, porta e top in ghisa. Versatile, può essere installata con scarico fumi superiore o posteriore. Disponibile nelle potenze 12kW e 14kW.

Sealed pellet stove with double ducting managed independently. Burning pot, cast iron top and door. With built-in Wi-Fi for remote control. Versatile, can be installed with top or rear smoke outlet. Available in 12kW and 14kW versions.

Poêle à pellets étanche à double canalisation et à gestion indépendante. Brasier, porte et couvercle en fonte. Il est doté de la connexion intégrée Wi-Fi pour le contrôle à distance. Polyvalent, il peut être installé en plaçant l'évacuation des fumées supérieure ou postérieure. Disponible dans les puissances 12 kW et 14 kW.

Luftdichter Pelletofen mit doppelter, unabhängig gesteuerter Luftkanalisierung. Brennschale, Tür und Topplatte aus Gusseisen. Mit integriertem W-LAN zur Fernsteuerung. Flexibler Einbau mit Rauchgasabzug oben oder hinten möglich. Erhältlich mit 12 kW oder 14 kW Leistung.





ATENA³ PLUS 12 / 14

NEW



Molteplici possibilità di canalizzazione dell'aria.

Multiple air ducting possibilities.

De nombreuses solutions de canalisation de l'air.

Mehrere Möglichkeiten zur Warmluftkanalisierung.



Uscita fumi superiore o posteriore.

Top or rear smoke outlet.

Sortie des fumées supérieure ou arrière.

Rauchgasabzug nach oben oder nach hinten



ATENA³ PLUS 12

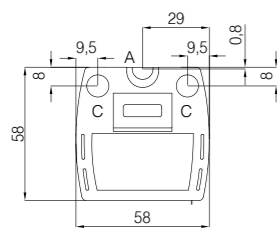

SOPRA - TOP - SUPÉRIEUR - OBER

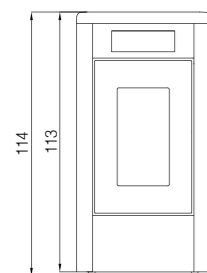

FRONTALE - FRONT - AVANT - VORDER

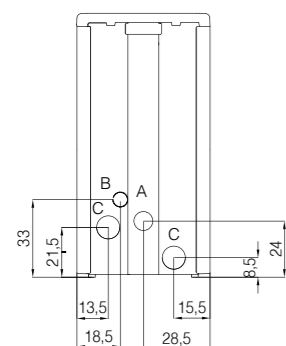

POSTERIORE - BACK - POSTÉRIEUR - HINTER

EUROPEAN STANDARDS



BimSchV 2015
Regensburg
München
Stuttgart
Aachen

EN 14785:2006



ENERGY LABELLING



TECHNICAL DATA

12 kW

12 kW	3,8 kW	90%	93,5%
0,86 kg/h 3,0 kg/h	8 h 27 h	91 m ³ 288 m ³	152 kg 160 kg
58 dB 65 dB	Pellet Ø 6 mm	23 kg	A Ø 80 mm B Ø 60 mm C Ø 80 mm



Kit canaliz. sup.
Upper ducting kit
Kit conduits de can. sup.
Kit für Kanalisierung oben



Kit concentrico sup.
Upper concentric kit
Kit concentrique sup.
Bausatz Konzentrisch oben



Maiolica Bianco
White Majolica
Céramique Blanc
Keramik Weiss



Maiolica Avorio
Ivory Majolica
Céramique Ivoire
Keramik Elfenbein



Maiolica Rosso
Red Majolica
Céramique Rouge
Keramik Rot



Metallo Bianco
White Steel
Acier Blanc
Metall Weiss



Metallo Avorio
Ivory Steel
Acier Ivoire
Metall Elfenbein



Metallo Titanium
Titanium Steel
Acier Titanium
Metall Titanium



Metallo Rosso
Red Steel
Acier Rouge
Metall Rot



Metallo Antracite
Anthracite Steel
Acier Anthracite
Metall Anthrazit

ATENA³ PLUS 12

7020018	EAN 8053859012061	Neutra / Neutral / Neutre / Neutral
6920014	EAN 8053859012146	Maiolica Bianco / White Majolica / Céramique Blanc / Keramik Weiss
6920013	EAN 8053859012139	Maiolica Avorio / Ivory Majolica / Céramique Ivoire / Keramik Elfenbein
6920015	EAN 8053859012153	Maiolica Rosso / Red Majolica / Céramique Rouge / Keramik Rot
6920010	EAN 8053859012108	Metallo Bianco / White Steel / Acier Blanc / Metall Weiss
6920009	EAN 8053859012092	Metallo Avorio / Ivory Steel / Acier Ivoire / Metall Elfenbein
6920012	EAN 8053859012122	Metallo Titanium / Titanium Steel / Acier Titanium / Metall Titanium
6920011	EAN 8053859012115	Metallo Rosso / Red Steel / Acier Rouge / Metall Rot
6920008	EAN 8053859012085	Metallo Antracite / Anthracite Steel / Acier Anthracite / Metall Anthrazit

OPTIONAL

5020003	EAN 8053859012573	Kit canaliz. sup. / Upper ducting kit / Kit conduits de canalisation sup. / Kit für Kanalisierung oben
5020004	EAN 8053859012580	Kit concentrico sup. / Upper concentric kit / Kit concentrique sup. / Bausatz Konzentrisch oben





ATENA³ PLUS 14

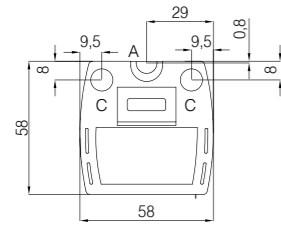

SOPRA - TOP - SUPÉRIEUR - OBER

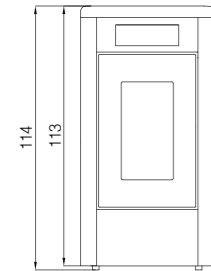

FRONTALE - FRONT - AVANT - VORDER

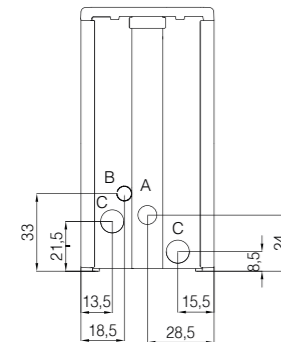

POSTERIORE - BACK - POSTÉRIEUR - HINTER

EUROPEAN STANDARDS

Art. 15A B-VG 2015
BImSchV 2015
Regensburg
München
Stuttgart
Aachen



EN 14785:2006



ENERGY LABELLING



TECHNICAL DATA

14 kW

14 kW	3,8 kW	89%	93,5%
0,86 kg/h 3,5 kg/h	7 h 27 h	91 m ³ 336 m ³	152 kg 160 kg
58 dB 65 dB	Pellet Ø 6 mm	23 kg	A Ø 80 mm B Ø 60 mm C Ø 80 mm



Kit canaliz. sup.
Upper ducting kit
Kit conduits de can. sup.
Kit für Kanalisierung oben



Kit concentrico sup.
Upper concentric kit
Kit concentrique sup.
Bausatz Konzentrisch oben



Maiolica Bianco
White Majolica
Céramique Blanc
Keramik Weiss



Maiolica Avorio
Ivory Majolica
Céramique Ivoire
Keramik Elfenbein



Maiolica Rosso
Red Majolica
Céramique Rouge
Keramik Rot



Metallo Bianco
White Steel
Acier Blanc
Metall Weiss



Metallo Avorio
Ivory Steel
Acier Ivoire
Metall Elfenbein



Metallo Titanium
Titanium Steel
Acier Titanium
Metall Titanium



Metallo Rosso
Red Steel
Acier Rouge
Metall Rot



Metallo Antracite
Anthracite Steel
Acier Anthracite
Metall Anthrazit

ATENA³ PLUS 14

7020019	EAN 8053859012078	Neutra / Neutral / Neutre / Neutral
6920014	EAN 8053859012146	Maiolica Bianco / White Majolica / Céramique Blanc / Keramik Weiss
6920013	EAN 8053859012139	Maiolica Avorio / Ivory Majolica / Céramique Ivoire / Keramik Elfenbein
6920015	EAN 8053859012153	Maiolica Rosso / Red Majolica / Céramique Rouge / Keramik Rot
6920010	EAN 8053859012108	Metallo Bianco / White Steel / Acier Blanc / Metall Weiss
6920009	EAN 8053859012092	Metallo Avorio / Ivory Steel / Acier Ivoire / Metall Elfenbein
6920012	EAN 8053859012122	Metallo Titanium / Titanium Steel / Acier Titanium / Metall Titanium
6920011	EAN 8053859012115	Metallo Rosso / Red Steel / Acier Rouge / Metall Rot
6920008	EAN 8053859012085	Metallo Antracite / Anthracite Steel / Acier Anthracite / Metall Anthrazit

OPTIONAL

5020003	EAN 8053859012573	Kit canaliz. sup. / Upper ducting kit / Kit conduits de canalisation sup. / Kit für Kanalisierung oben
5020004	EAN 8053859012580	Kit concentrico sup. / Upper concentric kit / Kit concentrique sup. / Bausatz Konzentrisch oben





PELLET HYDRO

Le termostufe Cadel sono una soluzione ottimale per l'impianto di riscaldamento domestico, riscaldando rapidamente l'acqua dei termosifoni, sono pratiche ed economiche ed uniscono la funzionalità ad un'estetica accattivante. Alcuni modelli sono disponibili nella versione H₂O: dotate di un apposito kit queste termostufe a pellet possono produrre acqua calda sanitaria.

Tutti i modelli di stufe Pellet Hydro sono certificati Classe Energetica A+, 4 stelle Aria Pulita, 7 stelle Flamme Verte e sono riconosciuti come idonei a ricevere il rimborso Conto Termico.

Cadel thermostoves are an excellent solution for domestic heating systems, since they quickly heat water in the radiators, they are convenient and cost-effective, and combine functionality with a charming design. Some models are available in the H₂O version: equipped with a special kit, these pellet thermostoves can produce domestic hot water.

All Pellet Hydro stove models are conform with the EcoDesign 2022 directives.

Les thermo-poêles Cadel sont une excellente solution pour le chauffage domestique, car ils chauffent rapidement l'eau des radiateurs, ils sont pratiques et économiques et allient fonctionnalité et aspect attrayant. Certains modèles sont disponibles dans la version H₂O : équipés d'un kit spécial, ces thermo-poêles à pellets peuvent produire de l'eau chaude sanitaire.

Tous les modèles de poeles pellet hydro sont certifiés 7 étoiles Flamme Vert et sont reconnus comme éligibles au crédit d'impôt. En outre, ils respectent les directives EcoDesign 2022.

Die Thermoöfen von Cadel sind eine optimale Lösung für Wohnungsheizanlagen. Sie sorgen für eine schnelle Erwärmung des Wassers in den Heizkörpern, sind praktisch und wirtschaftlich und verbinden Funktionalität mit attraktiver Ästhetik. Einige Modelle sind auch in der Version H₂O erhältlich: Mit einem speziellen Bausatz ausgestattet können diese Pelletöfen auch das Warmwasser liefern.

Alle Pelletofen-Modelle der Linie Hydro sind Bimsch 2015 (Regensburg, Munchen, Stuttgart, Aachen) , Klima Energiefonds und BAFA zertifiziert.





SATURNO 16 / 24

NEW

Saturno è un inserto idro dal design minimale, completo di kit idraulico, ventilazione frontale e caricamento pellet orientabile. Disponibile nelle versioni 16 kW e 24 kW.

Saturno is a hydro insert featuring a minimalist design, supplied with hydraulic kit, front ventilation and adjustable pellet loading. Available in 16 kW and 24 kW versions.

Saturno est un insert hydro au design minimaliste, doté d'un kit hydraulique, d'une ventilation frontale et d'un dispositif de chargement des pellets orientable. Il est disponible dans les versions 16 kW et 24 kW.

Saturno ist ein Hydro-Kamineinsatz mit minimalistischem Design. Er ist mit Hydraulik-Bausatz, frontaler Ventilation und ausrichtbarer Pelletklappe ausgestattet. Erhältlich in den Ausführungen mit 16 kW und 24 kW.





SATURNO 16 / 24

NEW



Ventilazione frontale.
 Front ventilation.
 Ventilation frontale.
 Frontale Lüftung.



Sistema di caricamento pellet orientabile.
 Adjustable pellet loading system.
 Système de chargement des pellets orientable.
 Schwenkbare Pelletklappe.



SATURNO 16 / 24

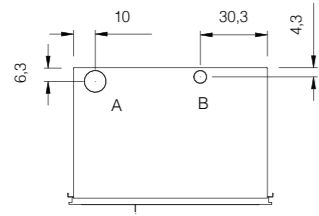

SOPRA - TOP - SUPÉRIEUR - OBER

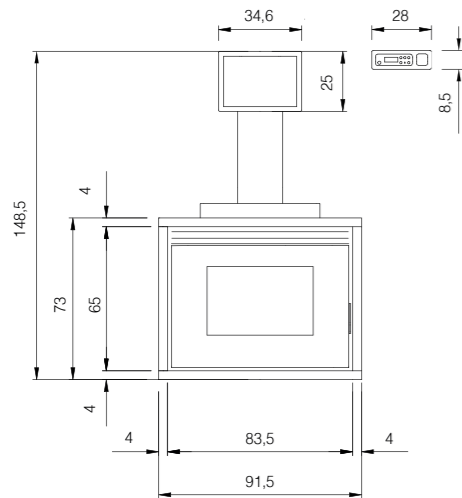

FRONTALE - FRONT - AVANT - VORDER

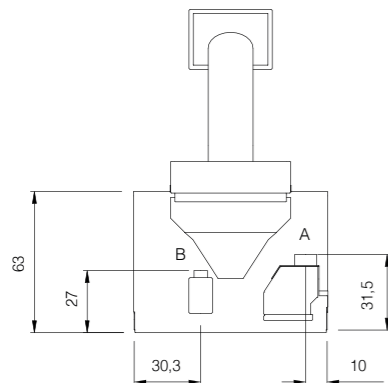

POSTERIORE - BACK - POSTÉRIEUR - HINTER

EUROPEAN STANDARDS

BimSchV 2015
Regensburg
München
Stuttgart
Aachen



EN 14785:2006



TECHNICAL DATA SATURNO 16*

* Dati da definire
Not defined data
Données à définir
Festzulegende Daten

16,2 kW

16,2 kW	4,7 kW	93,3%	96,5%	12,9 kW	3,1 kW
1 kg/h 3,5 kg/h	6,3 h 22 h	113 m ³ 389 m ³	140 kg	L 100 cm P 70 cm H 100 cm	0,70 m ³
43 dB 49 dB	Pellet Ø 6 mm	22 kg	A Ø 80 mm	B Ø 50 mm	

SATURNO 16

7020016 EAN 8053859012269 Metallo Nero / Black Steel / Acier Noir / Metall Schwarz



TECHNICAL DATA SATURNO 24*

* Dati da definire
Not defined data
Données à définir
Festzulegende Daten

22,8 kW

22,8 kW	4,7 kW	91,3%	96,5%	18,7 kW	3,1 kW
1 kg/h 5 kg/h	4,4 h 22 h	113 m ³ 547 m ³	140 kg	L 100 cm P 70 cm H 100 cm	0,70 m ³
43 dB 49 dB	Pellet Ø 6 mm	22 kg	A Ø 80 mm	B Ø 50 mm	

SATURNO 24

7020017 EAN 8053859012276 Metallo Nero / Black Steel / Acier Noir / Metall Schwarz



Kit gambe
Kit podium
Socle de support
Kit Sockel

OPTIONAL

5020015 EAN 8053859012832 Kit gambe / Kit podium / Socle de support / Kit Sockel





MAYA³ 16 / 24

NEW



Vera novità del 2020, Maya³ completa la gamma delle stufe idro.

La stufa ventilata pensata per gli spazi ristretti ha un rivestimento in metallo ed è disponibile nelle versioni 16 kW e 24 kW.

The true new entry of 2020, Maya³ completes our range of hydro stoves. The ventilated hydro stove designed for small spaces comes with metal cladding and is available in 16 kW and 24 kW versions.

Véritable nouveauté de l'année 2020, Maya³ complète la gamme des poêles hydro. Le poêle hydro ventilé conçu pour les espaces réduits, doté d'un revêtement en métal, est disponible dans les versions 16 kW et 24 kW.

Maya³ ist eine echte Neuheit des Jahres 2020 und ergänzt das Angebot an Hydro-Pelletöfen. Dieser belüftete Hydro-Pelletöfen für kleine Räume ist mit Metall verkleidet und in Ausführungen mit 16 kW und 24 kW erhältlich.



MAYA³ 16 / 24

NEW



Adatta a spazi ristretti.

Suitable for confined spaces.

Indiqué pour les espaces réduits.

Für enge Bereiche geeignet.



Cura dei dettagli estetici e comodo accesso al display.

Attention to the aesthetic details and convenient access to the display.

Soin des détails esthétiques et accès facile à l'écran.

Mit Augenmerk auf den ästhetischen Details und bequemen Zugang zum Display.



MAYA³ 16

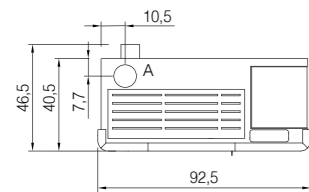

SOPRA - TOP - SUPÉRIEUR - OBER

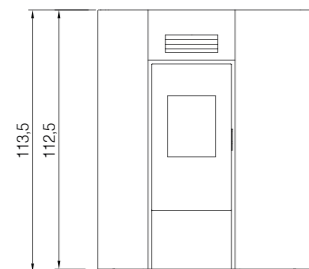

FRONTALE - FRONT - AVANT - VORDER

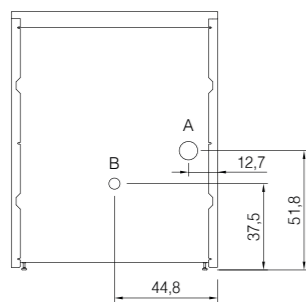

POSTERIORE - BACK - POSTÉRIEUR - HINTER



EUROPEAN STANDARDS

BimSchV 2015
Regensburg
München
Stuttgart
Aachen



EN 14785:2006



ENERGY LABELLING



TECHNICAL DATA

16,2 kW

16,2 kW	4,7 kW	93,3%	96,5%	12,9 kW	3,1 kW
1 kg/h 3,5 kg/h	6,3 h 22 h	113 m ³ 389 m ³	151,5 kg	L 120 cm P 60 cm H 120 cm	0,86 m ³
43 dB 49 dB	Pellet Ø 6 mm	22 kg	A Ø 80 mm	B Ø 50 mm	



Metallo Bianco
White Steel
Acier Blanc
Metall Weiss



Metallo Light Bronze
Light Bronze Steel
Acier Light Bronze
Metall Light Bronze



Metallo Titanium
Titanium Steel Acier
Titanium Metall
Titanium



Metallo Rosso
Red Steel
Acier Rouge
Metall Rot



Metallo Antracite
Anthracite Steel
Acier Anthracite
Metall Anthrazit

MAYA³ 16

7020020	EAN 8053859012283	Neutra / Neutral / Neutre / Neutral
6920017	EAN 8053859012313	Metallo Bianco / White Steel / Acier Blanc / Metall Weiss
6920018	EAN 8053859012320	Metallo Light Bronze / Light Bronze Steel / Acier Light Bronze / Metall Light Bronze
6920020	EAN 8053859012344	Metallo Titanium / Titanium Steel / Acier Titanium / Metall Titanium
6920019	EAN 8053859012337	Metallo Rosso / Red Steel / Acier Rouge / Metall Rot
6920016	EAN 8053859012306	Metallo Antracite / Anthracite Steel/ Acier Anthracite / Metall Anthrazit





MAYA³ 24

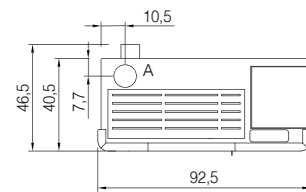

SOPRA - TOP - SUPÉRIEUR - OBER

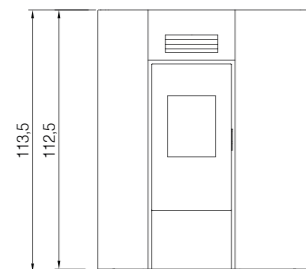

FRONTALE - FRONT - AVANT - VORDER

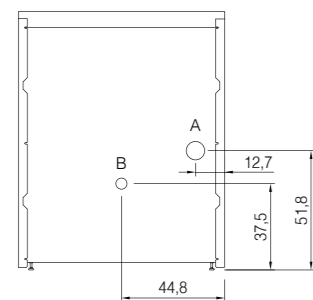

POSTERIORE - BACK - POSTÉRIEUR - HINTER



EUROPEAN STANDARDS

BimSchV 2015
Regensburg
München
Stuttgart
Aachen



EN 14785:2006



ENERGY LABELLING



TECHNICAL DATA

22,8 kW



22,8 kW



4,7 kW



91,3%



96,5%



18,7 kW



3,1 kW



1 kg/h
5 kg/h



4,4 h
22 h



113 m³
547 m³



151,5 kg



L 120 cm
P 60 cm
H 120 cm



0,86 m³



43 dB
49 dB



Pellet
Ø 6 mm



22 kg



A Ø 80 mm



B Ø 50 mm



Metallo Bianco
White Steel
Acier Blanc
Metall Weiss



Metallo Light Bronze
Light Bronze Steel
Acier Light Bronze
Metall Light Bronze



Metallo Titanium
Titanium Steel Acier
Titanium Metall
Titanium



Metallo Rosso
Red Steel
Acier Rouge
Metall Rot



Metallo Antracite
Anthracite Steel
Acier Anthracite
Metall Anthrazit

MAYA³ 24

7020021	EAN 8053859012290	Neutra / Neutral / Neutre / Neutral
6920017	EAN 8053859012313	Metallo Bianco / White Steel / Acier Blanc / Metall Weiss
6920018	EAN 8053859012320	Metallo Light Bronze / Light Bronze Steel / Acier Light Bronze / Metall Light Bronze
6920020	EAN 8053859012344	Metallo Titanium / Titanium Steel / Acier Titanium / Metall Titanium
6920019	EAN 8053859012337	Metallo Rosso / Red Steel / Acier Rouge / Metall Rot
6920016	EAN 8053859012306	Metallo Antracite / Anthracite Steel / Acier Anthracite / Metall Anthrazit





IDRO PRINCE³ 12



Stufa a pellet idro dal design semplice e curato, caratterizzata da un impianto idraulico che sfrutta a pieno il calore generato distribuendolo in tutti gli spazi di una piccola abitazione.

The hydro pellet stove with a simple and nice design, distinguished by a hydraulic system that fully exploits the generated heat by distributing it in all the spaces of a small home.

Poêle à pellets hydro au design simple et soigné, caractérisé par un circuit hydraulique qui exploite pleinement la chaleur générée en la distribuant dans tous les espaces d'une petite habitation.

Ein wasserführender Pelletofen mit einfachem und sorgfältig durchdachtem Design, der die gesamte erzeugte Wärme nutzt und sie in einer kleinen Wohnung überall verteilt.



IDRO PRINCE³ 12

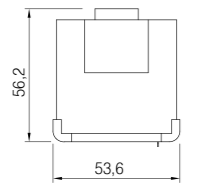

SOPRA - TOP - SUPÉRIEUR - OBER

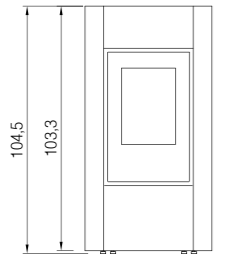

FRONTALE - FRONT - AVANT - VORDER

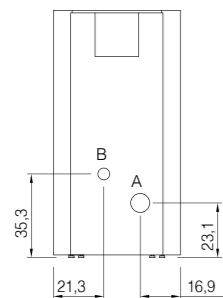

POSTERIORE - BACK - POSTÉRIEUR - HINTER



EUROPEAN STANDARDS

Art. 15A B-VG 2015
BImSchV 2015
Regensburg
München
Stuttgart
Aachen



EN 14785:2006



TECHNICAL DATA

11,8 kW



11,8 kW



3,2 kW



91,8%



92,4%



10,2 kW



2,2 kW



0,7 kg/h
2,6 kg/h



8,5 h
31,4 h



77 m³
283 m³



132,1 kg



L 80 cm
P 70 cm
H 131,8 cm



0,74 m³



43 dB
49 dB



Pellet
Ø 6 mm



22 kg



A Ø 80 mm



B Ø 50 mm



Metallo Bianco
White Steel
Acier Blanc
Metall Weiss



Metallo Light Bronze
Light Bronze Steel
Acier Light Bronze
Metall Light Bronze



Metallo Titanium
Titanium Steel
Acier Titanium
Metall Titanium



Metallo Rosso
Red Steel
Acier Rouge
Metall Rot



Metallo Antracite
Anthracite Steel
Acier Anthracite
Metall Anthrazit

IDRO PRINCE³ 12

7017061	EAN 8033123618984	Neutra / Neutral / Neutre / Neutral
6917025	EAN 8033123619028	Metallo Bianco / White Steel / Acier Blanc / Metall Weiss
6917026	EAN 8033123619035	Metallo Light Bronze / Light Bronze Steel / Acier Light Bronze / Metall Light Bronze
6919015	EAN 8053859011293	Metallo Titanium / Titanium Steel / Acier Titanium / Metall Titanium
6917028	EAN 8033123619059	Metallo Rosso / Red Steel / Acier Rouge / Metall Rot
6917029	EAN 8033123619066	Metallo Antracite / Anthracite Steel / Acier Anthracite / Metall Anthrazit





IDRO PRINCE³ 16 / 23 / 23 H₂O



Stufa a pellet idro dal design semplice e lineare, caratterizzata da una potente ventilazione e da un impianto idraulico che sfrutta a pieno il calore generato distribuendolo in tutti gli spazi di una abitazione di medie dimensioni. Disponibile anche un kit per scaldare l'acqua sanitaria.

The hydro pellet stove with a simple and linear design, distinguished by powerful ventilation and a hydraulic system that fully exploits the generated heat by distributing it in all the spaces of a mid-sized home. A kit to heat domestic hot water is also available

Poêle à pellets hydro au design simple et linéaire, caractérisé par une ventilation puissante et par un circuit hydraulique qui exploite totalement la chaleur générée en la distribuant dans tous les espaces d'une habitation de taille moyenne. Un kit pour chauffer l'eau sanitaire est également disponible.

Ein wasserführender Pelletofen mit einfachem und linearem Design, der über eine leistungsstarke Belüftung und eine Hydraulikanlage verfügt, die die gesamte erzeugte Wärme nutzt und sie in einer mittelgroßen Wohnung überall verteilt. Auch ein Bausatz zum Erhitzen von Brauchwasser ist lieferbar.

IDRO PRINCE³ 16 / 23 / 23 H₂O

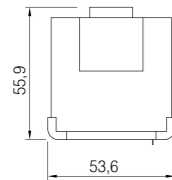

SOPRA - TOP - SUPÉRIEUR - OBER

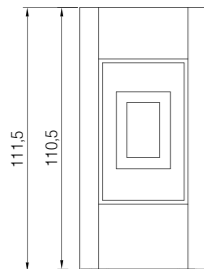

FRONTALE - FRONT - AVANT - VORDER

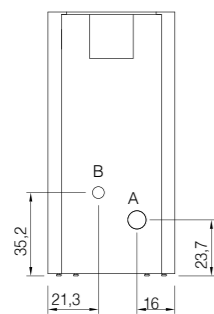

POSTERIORE - BACK - POSTÉRIEUR - HINTER



EUROPEAN STANDARDS

Art. 15A B-VG 2015
BImSchV 2015
Regensburg
München
Stuttgart
Aachen



EN 14785:2006



ENERGY LABELLING



TECHNICAL DATA IDRO PRINCE³ 16

16,2 kW

16,2 kW	4,7 kW	93,3%	96,5%	12,9 kW	3,1 kW
1,0 kg/h 3,5 kg/h	6,3 h 22 h	113 m ³ 389 m ³	136 kg	L 80 cm P 70 cm H 131,8 cm	0,74 m ³
43 dB 49 dB	Pellet Ø 6 mm	22 kg	A Ø 80 mm	B Ø 50 mm	



Metallo Bianco
White Steel
Acier Blanc
Metall Weiss



Metallo Light Bronze
Light Bronze Steel
Acier Light Bronze
Metall Light Bronze



Metallo Titanium
Titanium Steel
Acier Titanium
Metall Titanium



Metallo Rosso
Red Steel
Acier Rouge
Metall Rot



Metallo Antracite
Anthracite Steel
Acier Anthracite
Metall Anthrazit

IDRO PRINCE³ 16

7017082	EAN 8033123619097	Neutra / Neutral / Neutre / Neutral
6917030	EAN 8033123619127	Metallo Bianco / White Steel / Acier Blanc / Metall Weiss
6917031	EAN 8033123619134	Metallo Light Bronze / Light Bronze Steel / Acier Light Bronze / Metall Light Bronze
6919007	EAN 8053859011224	Metallo Titanium / Titanium Steel / Acier Titanium / Metall Titanium
6917033	EAN 8033123619158	Metallo Rosso / Red Steel / Acier Rouge / Metall Rot
6917034	EAN 8033123619165	Metallo Antracite / Anthracite Steel / Acier Anthracite / Metall Anthrazit



TECHNICAL DATA IDRO PRINCE³ 23 **22,8 kW**

22,8 kW	4,7 kW	91,3%	96,5%	18,7 kW	3,1 kW
1,0 kg/h 5,0 kg/h	4,4 h 22 h	113 m ³ 547 m ³	136 kg	L 80 cm P 70 cm H 131,8 cm	0,74 m ³
43 dB 49 dB	Pellet Ø 6 mm	22 kg	A Ø 80 mm	B Ø 50 mm	



Metallo Bianco White Steel Acier Blanc Metall Weiss	Metallo Light Bronze Light Bronze Steel Acier Light Bronze Metall Light Bronze	Metallo Titanium Titanium Steel Acier Titanium Metall Titanium	Metallo Rosso Red Steel Acier Rouge Metall Rot	Metallo Antracite Anthracite Steel Acier Anthracite Metall Anthrazit
--	---	---	---	---

IDRO PRINCE³ 23

7017083	EAN 8033123619103	Neutra / Neutral / Neutre / Neutral
6917030	EAN 8033123619127	Metallo Bianco / White Steel / Acier Blanc / Metall Weiss
6917031	EAN 8033123619134	Metallo Light Bronze / Light Bronze Steel / Acier Light Bronze / Metall Light Bronze
6919007	EAN 8053859011224	Metallo Titanium / Titanium Steel / Acier Titanium / Metall Titanium
6917033	EAN 8033123619158	Metallo Rosso / Red Steel / Acier Rouge / Metall Rot
6917034	EAN 8033123619165	Metallo Antracite / Anthracite Steel / Acier Anthracite / Metall Anthrazit



TECHNICAL DATA IDRO PRINCE³ 23 H₂O **22,8 kW**

22,8 kW	4,7 kW	91,3%	96,5%	18,7 kW	3,1 kW
1,0 kg/h 5,0 kg/h	4,4 h 22 h	113 m ³ 547 m ³	139 kg	L 80 cm P 70 cm H 131,8 cm	0,74 m ³
43 dB 49 dB	Pellet Ø 6 mm	22 kg	A Ø 80 mm	B Ø 50 mm	

Kit completo Idro riscaldamento + acqua sanitaria
Complete kit heating + domestic water
Kit complet Idro chauffage + eau sanitaire
Komplett-Set Hydro Heizung + Brauchwasser



Metallo Bianco White Steel Acier Blanc Metall Weiss	Metallo Light Bronze Light Bronze Steel Acier Light Bronze Metall Light Bronze	Metallo Titanium Titanium Steel Acier Titanium Metall Titanium	Metallo Rosso Red Steel Acier Rouge Metall Rot	Metallo Antracite Anthracite Steel Acier Anthracite Metall Anthrazit
--	---	---	---	---

IDRO PRINCE³ 23 H₂O

7017084	EAN 8033123619110	Neutra / Neutral / Neutre / Neutral
6917030	EAN 8033123619127	Metallo Bianco / White Steel / Acier Blanc / Metall Weiss
6917031	EAN 8033123619134	Metallo Light Bronze / Light Bronze Steel / Acier Light Bronze / Metall Light Bronze
6919007	EAN 8053859011224	Metallo Titanium / Titanium Steel / Acier Titanium / Metall Titanium
6917033	EAN 8033123619158	Metallo Rosso / Red Steel / Acier Rouge / Metall Rot
6917034	EAN 8033123619165	Metallo Antracite / Anthracite Steel / Acier Anthracite / Metall Anthrazit





IDRO PRINCE 30



Stufa a pellet idro dal design imponente è caratterizzata da una potenza di 30 kW e da un impianto idraulico che sfrutta a pieno il calore generato distribuendolo in tutti gli spazi circostanti. Disponibile anche un kit per scaldare l'acqua sanitaria.

The hydro pellet stove with an impressive design is distinguished by 30 kW power and a hydraulic system that fully exploits the generated heat by distributing it in all the surrounding spaces. A kit to heat domestic hot water is also available.

Ce poêle à pellets hydro au design imposant est caractérisé par une puissance de 30 kW et par un circuit hydraulique qui exploite pleinement la chaleur générée en la distribuant dans tous les espaces alentour. Un kit pour chauffer l'eau sanitaire est également disponible.

Ein wasserführender Pelletofen mit beeindruckendem Design, der eine Leistung von 30 Watt und eine Hydraulikanlage aufweist, die die gesamte erzeugte Wärme nutzt und sie in allen umliegenden Räumen verteilt. Auch ein Bausatz zum Erhitzen von Brauchwasser ist lieferbar.



IDRO PRINCE 30

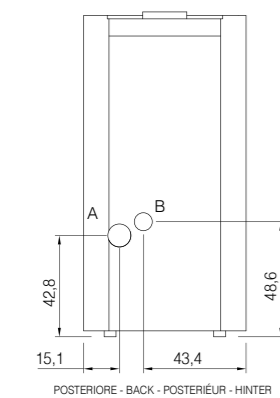
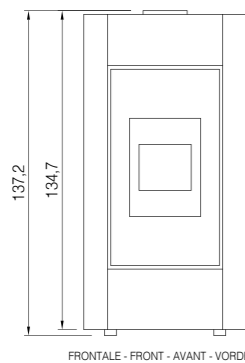
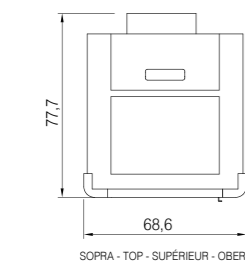

EUROPEAN STANDARDS

BImSchV 2015
Regensburg
München
Stuttgart
Aachen



EN 14785:2006



TECHNICAL DATA

28,6 kW



28,6 kW



7,7 kW



93,6%



94,7%



26,9 kW



6,2 kW



1,7 kg/h
6,33 kg/h



7,6 h
28,2 h



185 m³
686 m³



265 kg



L 80 cm
P 90 cm
H 152 cm



1,09 m³



47 dB
58 dB



Pellet
Ø 6 mm



48 kg



A Ø 100 mm



B Ø 80 mm



Metallo Bianco
White Steel
Acier Blanc
Metall Weiss



Metallo Rosso
Red Steel
Acier Rouge
Metall Rot

IDRO PRINCE 30

7018022	EAN 8053859010043	Neutra / Neutral / Neutre / Neutral
6918019	<input type="checkbox"/> EAN 8053859010241	Metallo Bianco / White Steel / Acier Blanc / Metall Weiss
6918018	<input checked="" type="checkbox"/> EAN 8053859010234	Metallo Rosso / Red Steel / Acier Rouge / Metall Rot





CUCINE A LEGNA

Wood cookers - Cuisines à bois - Holzherde

Conformi alle normative ambientali più severe, i prodotti a legna Cadel a libera installazione e da incasso uniscono il riscaldamento domestico, la versatilità installativa e l'estetica elegante. Grazie a attente soluzioni costruttive questi prodotti non necessitano di ulteriori kit per l'inserimento all'interno di un mobile cucina, e le finiture curate permettono di poterle installare anche liberamente in ambiente. La gamma di prodotti a legna offre soluzioni estetiche adatte sia ad ambienti contemporanei che di gusto più classico senza però trascurare la tradizione culinaria grazie al loro ampio forno. Sono caratterizzate da un ampio forno cottura, la piastra in ghisa, un comodo cassetto portalegna e un'ampia camera di combustione con interno in refrattario.

Compliant with the strictest environmental regulations, Cadel's free and recessed installation wood products combine home heating with versatile installation and elegant aesthetics.

Thanks to meticulous construction solutions, these products do not require additional kits for insertion in kitchen units, and the curate finishes allow for free installation in the room.

The range of wood products offers both aesthetics that suit contemporary rooms as well as the most classic style without, however, forgetting culinary tradition thanks to the generous oven.

They are distinguished by a large oven, a cast iron hot plate, a practical log drawer and a large combustion chamber with a refractory interior.

All Wood burning Cookers are conform with the EcoDesign 2022 directives.

Conformes aux réglementations environnementales les plus strictes, les produits à bois Cadel autonomes et encastrables allient le chauffage domestique, la polyvalence d'installation et l'esthétique élégante. Grâce à des solutions de construction soignées, ces produits ne nécessitent pas de kits supplémentaires pour l'insertion dans un meuble de cuisine, et les finitions raffinées permettent de les installer librement dans la pièce. La gamme des produits à bois comprend des solutions esthétiques, parfaites pour les décors contemporains ou pour ceux qui préfèrent un ameublement plus classique, sans pour autant négliger la tradition culinaire grâce à leur grand four. Elles sont caractérisées par un grand four de cuisson, la plaque en fonte, un tiroir à bois pratique et une vaste chambre de combustion avec l'intérieur en matériau réfractaire.

Toutes les cuisinières bois CADEL sont certifiées 7 étoiles Flamme Vert et elles respectent les directives EcoDesign 2022 .

Die holzgefeuerten Geräte von Cadel zur freistehenden Installation und zum Einbau vereinen in sich das Heizen der Wohnung, die Flexibilität bei der Installation und ein elegantes Design. Dank ihrer besonderen Bauart ist bei diesen Geräten kein zusätzlicher Bausatz für den Einbau in eine Küchenzeile erforderlich, und durch die edlen Oberflächen ist die Installation auch freistehend im Raum möglich.

Die holzgefeuerten Geräte sind sowohl in modernem Design als auch in klassischerem Stil erhältlich. Und dank ihrem großen Backofen ist auch Kochen und Backen kein Problem.

Sie verfügen über einen großen Backofen, eine Gusseisenplatte, eine praktische Schublade für das Holz und eine große Brennkammer mit Innenverkleidung aus Schamottstein.

Alle Holzherde sind Bimsch 2015 (Regensburg, München, Stuttgart, Aachen) zertifiziert und respektieren die EcoDesign 2022 Richtlinien.





SMART 60 / 80

NEW

**LE SMART 60 E 80 SODDISFANO
I REQUISITI PER IL CONTO TERMICO**

A libera installazione o da inserimento, queste due nuove cucine versatili si adattano a qualsiasi ambiente. Caratterizzate da porte in ghisa, eleganti maniglie e corrimano in acciaio, camera di combustione con interno in refrattario. Tra gli accessori sono disponibili dei piedini estetici e uno zoccolo in acciaio.

Either free-standing or built-in, these new versatile range cookers suit any setting. They feature cast iron doors, elegant steel handles and handrail, and combustion chamber with refractory material interior. The accessories include decorative feet and a steel base.

À installation libre ou à encastrer, ces deux nouvelles cuisinières polyvalentes s'adaptent à tout espace. Elles se caractérisent par des portes en fonte, d'élégantes poignées et une main courante en acier, une chambre de combustion avec intérieur en matériel réfractaire. Des pieds esthétiques et un socle en acier font partie des accessoires disponibles.

Diese beiden flexiblen neuen Herde für die freistehende Installation oder zum Einbau eignen sich für jede Küche. Charakteristisch sind Gusseisen Türen, die eleganten Griffe und Handläufe aus Stahl sowie die Brennkammer mit Innenauskleidung aus Schamotte. Als Zubehör sind unter anderem Zierfüße und ein Sockel aus Stahl erhältlich.

**SMART 60 / 80****NEW**

Ampio e utile cassetto porta oggetti.

Generous and practical storage compartment.

Grand tiroir porte-objets, très utile.

Große, nützliche Ablagebox..

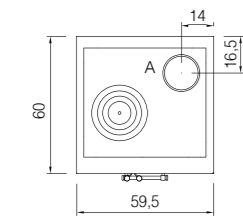
**SMART 60**

SOPRA - TOP - SUPÉRIEUR - OBER

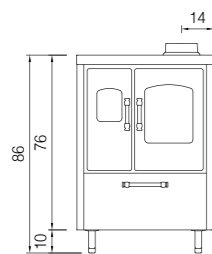

FRONTALE - FRONT - AVANT - VORDER

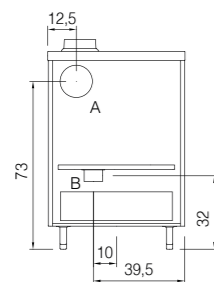

POSTERIORE - BACK - POSTÉRIEUR - HINTER



EUROPEAN STANDARDS

Art. 15A B-VG 2015
BImSchV 2015
Regensburg
München
Stuttgart
Aachen



EN 12815:2001/A1:2004/AC:2007



ENERGY LABELLING

**TECHNICAL DATA***

* Dati da definire
Not defined data
Données à définir
Festzulegende Daten

6,2 kW

6,2 kW



85,1%



1,7 kg/h

149 m³

128,1 kg

L 24 cm
P 42 cm
H 29 cmL 15 cm
H 15 cm

4 cm

L 77 cm
P 79 cm
H 100,5 cm0,61 m³

L 33 cm



Ø 140 mm



Ø 80 mm



Piedini Estetici
Feet
Pieds
Füße



Zoccolo Inox Smart 60
Podium Smart 60
Socle Smart 60
Sockel Smart 60



Alzatina Inox H4
H4 Upstand
Bord relevé H4
H4 Hochrand



Alzatina Inox H6
H6 Upstand
Bord relevé H6
H6 Hochrand



Coperchio
Top
Couvercle
Deckel



Metallo Bianco
White Steel
Acier Blanc
Metall Weiss



Metallo Rosso
Red Steel
Acier Rouge
Metall Rot



Metallo Antracite
Anthracite Steel
Acier Anthracite
Metall Anthrazit

SMART 60

71200010	EAN 8053859012160	Neutra / Neutral / Neutre / Neutral
71200011	EAN 8053859012177	Neutra / Neutral / Neutre / Neutral Smart 60 con kit ventilazione + luce Smart 60 with ventilation + light kit Smart 60 avec ventilation + éclairage Smart 60 mit Lüftung kit + Beleuchtung
6920003	EAN 8053859012214	Metallo Bianco / White Steel / Acier Blanc / Metall Weiss
6920004	EAN 8053859012221	Metallo Rosso / Red Steel / Acier Rouge / Metall Rot
6920002	EAN 8053859012207	Metallo Antracite / Anthracite Steel / Acier Anthracite / Metall Anthrazit

OPTIONAL

5020005	EAN 8053859012597	Piedini Estetici / Feet / Pieds / Füße
5020006	EAN 8053859012603	Zoccolo Inox Smart 60 / Podium Smart 60 / Socle Smart 60 / Sockel Smart 60
5020008	EAN 8053859012627	Alzatina Inox H4 / H4 Upstand / Bord relevé H4 / H4 Hochrand
5020009	EAN 8053859012634	Alzatina Inox H6 / H6 Upstand / Bord relevé H6 / H6 Hochrand
5020014	EAN 8053859012689	Coperchio / Top / Couvercle / Deckel

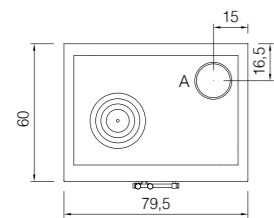

**SMART 80**

SOPRA - TOP - SUPÉRIEUR - OBER

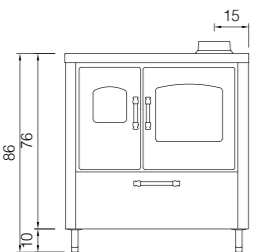

FRONTALE - FRONT - AVANT - VORDER

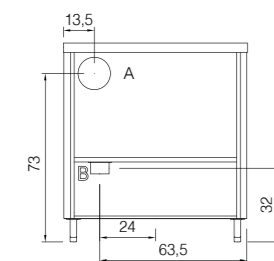

POSTERIORE - BACK - POSTÉRIEUR - HINTER



EUROPEAN STANDARDS

Art. 15A B-VG 2015
BImSchV 2015
Regensburg
München
Stuttgart
Aachen



EN 12815:2001/A1:2004/AC:2007



ENERGY LABELLING

**TECHNICAL DATA***

* Dati da definire
Not defined data
Données à définir
Festzulegende Daten

7,5 kW

7,5 kW



85,1%



2,2 kg/h

180 m³

138,2 kg

L 33 cm
P 42 cm
H 29 cmL 17,2 cm
H 16,7 cm

4 cm

L 97 cm
P 79 cm
H 102,1 cm0,78 m³

L 33 cm



Ø 140 mm



Ø 80 mm



Piedini Estetici
Feet
Pieds
Füße



Zoccolo Inox Smart 80
Podium Smart 80
Socle Smart 80
Sockel Smart 80



Alzatina Inox H4
H4 Upstand
Bord relevé H4
H4 Hochrand



Alzatina Inox H6
H6 Upstand
Bord relevé H6
H6 Hochrand



Coperchio
Top
Couvercle
Deckel



Metallo Bianco
White Steel
Acier Blanc
Metall Weiss



Metallo Rosso
Red Steel
Acier Rouge
Metall Rot



Metallo Antracite
Anthracite Steel
Acier Anthracite
Metall Anthrazit

SMART 80

71200020	EAN 8053859012184	Neutra / Neutral / Neutre / Neutral
71200021	EAN 8053859012191	Neutra / Neutral / Neutre / Neutral Smart 80 con kit ventilazione + luce Smart 80 with ventilation + light kit Smart 80 avec ventilation + éclairage Smart 80 mit Lüftung kit + Beleuchtung
6920006	<input type="checkbox"/> EAN 8053859012245	Metallo Bianco / White Steel / Acier Blanc / Metall Weiss
6920007	<input checked="" type="checkbox"/> EAN 8053859012252	Metallo Rosso / Red Steel / Acier Rouge / Metall Rot
6920005	<input checked="" type="checkbox"/> EAN 8053859012238	Metallo Antracite / Anthracite Steel / Acier Anthracite / Metall Anthrazit

OPTIONAL

5020005	EAN 8053859012597	Piedini Estetici / Feet / Pieds / Füße
5020007	EAN 8053859012610	Zoccolo Inox Smart 80 / Podium Smart 80 / Socle Smart 80 / Sockel Smart 80
5020010	EAN 8053859012641	Alzatina Inox H4 / H4 Upstand / Bord relevé H4 / H4 Hochrand
5020011	EAN 8053859012658	Alzatina Inox H6 / H6 Upstand / Bord relevé H6 / H6 Hochrand
5013003	EAN 8033123613361	Coperchio / Top / Couvercle / Deckel

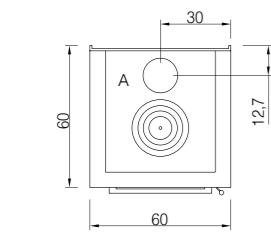

**KOOK 60 4.0**

SOPRA - TOP - SUPÉRIEUR - OBER

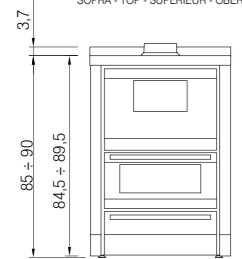

FRONTALE - FRONT - AVANT - VORDER

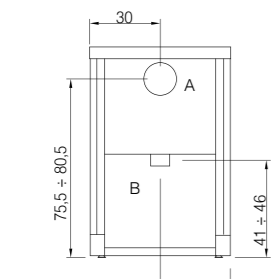

POSTERIORE - BACK - POSTÉRIEUR - HINTER



EUROPEAN STANDARDS

Art. 15A B-VG 2015
BImSchV 2015
Regensburg
München
Stuttgart
Aachen
EN 12815:2001/A1-2004/AC:2007



ENERGY LABELLING

**TECHNICAL DATA****6,2 kW**

6,2 kW



84,1%



1,7 kg/h

149 m³

121,6 kg

L 37 cm
P 34 cm
H 16,5 cmL 26,1 cm
H 14,4 cmI h
4 cmL 77 cm
P 79 cm
H 100,5 cm0,61 m³

L 33 cm



Ø 140 mm



Ø 80 mm

Coperchio
Top
Couvercle
DeckelMetallo Bianco
White Steel
Acier Blanc
Metall WeissAcciaio Inox
Inox Steel
Acier Inox
EdelstahlMetallo Antracite
Anthracite Steel
Acier Anthracite
Metall AnthrazitMetallo Nero
Black Steel
Acier Noir
Metall Schwarz**KOOK 60 4.0**

71180060	EAN 8053859010548	Neutra / Neutral / Neutre / Neutral
71180061	EAN 8053859010555	Neutra / Neutral / Neutre / Neutral Kook 60 4.0 con kit ventilazione + luce Kook 60 4.0 with ventilation + light kit Kook 60 4.0 avec ventilation + éclairage Kook 60 4.0 mit Lüftung kit + Beleuchtung
6915051	<input type="checkbox"/> EAN 8033123617116	Metallo Bianco / White Steel / Acier Blanc / Metall Weiss
6915036	<input type="checkbox"/> EAN 8033123616829	Acciaio Inox / Inox Steel / Acier Inox / Edelstahl
6915035	<input type="checkbox"/> EAN 8033123616812	Metallo Antracite / Anthracite Steel / Acier Anthracite / Metall Anthrazit
6915034	<input type="checkbox"/> EAN 8033123616805	Metallo Nero / Black Steel / Acier Noir / Metall Schwarz
OPTIONAL		
5018015	EAN 8053859012863	Coperchio / Top / Couvercle / Deckel

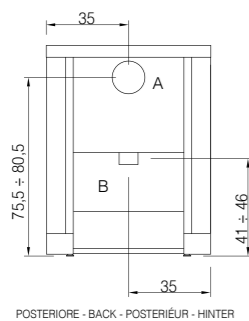
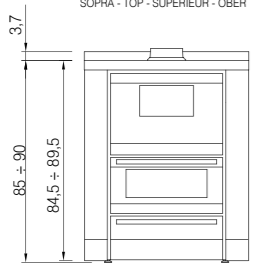
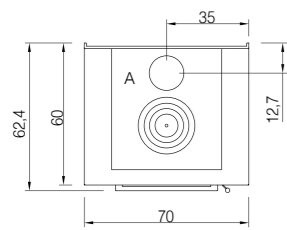

**KOOK 70 4.0**

EUROPEAN STANDARDS

Art. 15A B-VG 2015
BlmSchV 2015
Regensburg
München
Stuttgart
Aachen

**TECHNICAL DATA****6,2 kW**

6,2 kW



84,1%



1,7 kg/h

149 m³

128,1 kg

L 37 cm
P 34 cm
H 16,5 cmL 26,1 cm
H 14,4 cmI h
4 cmL 77 cm
P 79 cm
H 100,5 cm0,61 m³

L 33 cm



Ø 140 mm



Ø 80 mm

Coperchio
Top
Couvercle
DeckelMetallo Bianco
White Steel
Acier Blanc
Metall WeissAcciaio Inox
Inox Steel
Acier Inox
EdelstahlMetallo Antracite
Anthracite Steel
Acier Anthracite
Metall AnthrazitMetallo Nero
Black Steel
Acier Noir
Metall Schwarz**KOOK 70 4.0**

71180070 EAN 8053859010562 Neutra / Neutral / Neutre / Neutral

71180071 EAN 8053859010579 Neutra / Neutral / Neutre / Neutral
Kook 70 4.0 con kit ventilazione + luce
Kook 70 4.0 with ventilation + light kit
Kook 70 4.0 avec ventilation + éclairage
Kook 70 4.0 mit Lüftung kit + Beleuchtung

6915052 EAN 8033123617123 Metallo Bianco / White Steel / Acier Blanc / Metall Weiss

6915039 EAN 8033123616850 Acciaio Inox / Inox Steel / Acier Inox / Edelstahl

6915038 EAN 8033123616843 Metallo Antracite / Anthracite Steel / Acier Anthracite / Metall Anthrazit

6915037 EAN 8033123616836 Metallo Nero / Black Steel / Acier Noir / Metall Schwarz

OPTIONAL

5018015 EAN 8053859012863 Coperchio / Top / Couvercle / Deckel

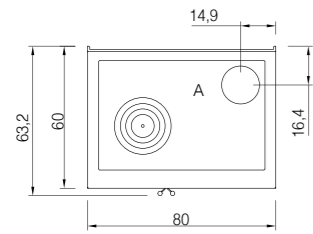

**KOOK 80**

SOPRA - TOP - SUPÉRIEUR - OBER

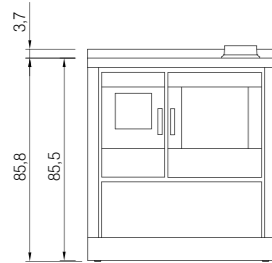

FRONTALE - FRONT - AVANT - VORDER

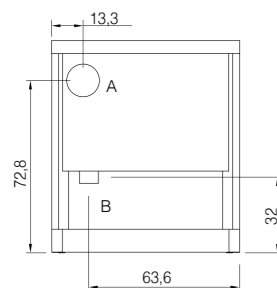

POSTERIORE - BACK - POSTÉRIEUR - HINTER



EUROPEAN STANDARDS

Art. 15A B-VG 2015
BlmSchV 2015
Regensburg
München
Stuttgart
Aachen

EN 12815:2001/A1:2004/AC:2007

**TECHNICAL DATA****7,5 kW**

7,5 kW



82,5%



2,2 kg/h

180 m³

138,2 kg

L 33 cm
P 42 cm
H 29 cmL 17,2 cm
H 16,7 cmI h
4 cmL 97 cm
P 79 cm
H 102,1 cm0,78 m³

L 33 cm



Ø 140 mm



Ø 80 mm

Coperchio
Top
Couvercle
DeckelMetallo Bianco
White Steel
Acier Blanc
Metall WeissAcciaio Inox
Inox Steel
Acier Inox
EdelstahlMetallo Antracite
Anthracite Steel
Acier Anthracite
Metall AnthrazitMetallo Nero
Black Steel
Acier Noir
Metall Schwarz**KOOK 80**

71150030	EAN 8033123617178	Kook 80 neutra piano in ghisa / Kook 80 with cast iron Top / Kook 80 avec plaque en fonte / Kook 80 mit Gusseisen-Kochplatte
71150031	EAN 8033123617185	Kook 80 neutra piano in ghisa ventilata / Kook 80 with cast iron Top with ventilation + light kit / Kook 80 avec plaque en fonte avec ventilation + éclairage / Kook 80 mit Gusseisen-Kochplatte mit Lüftung kit + Beleuchtung
71150060	EAN 8033123617239	Kook 80 neutra piano in vetroceramica / Kook 80 with glass-ceramic Top / Kook 80 avec plaque vitrocéramique / Kook 80 mit Glaskeramik-Kochplatte
71150061	EAN 8033123617246	Kook 80 neutra piano in vetroceramica ventilata / Kook 80 with glass-ceramic Top with ventilation + light kit / Kook 80 avec plaque vitrocéramique avec ventilation + éclairage / Kook 80 mit Glaskeramik-Kochplatte mit Lüftung kit + Beleuchtung
6915051	 EAN 8033123617116	Metallo Bianco / White Steel / Acier Blanc / Metall Weiss
6915036	 EAN 8033123616829	Acciaio Inox / Inox Steel / Acier Inox / Edelstahl
6915035	 EAN 8033123616812	Metallo Antracite / Anthracite Steel / Acier Anthracite / Metall Anthrazit
6915034	 EAN 8033123616805	Metallo Nero / Black Steel / Acier Noir / Metall Schwarz

OPTIONAL

5013003	EAN 8033123613361	Coperchio / Top / Couvercle / Deckel
---------	-------------------	--------------------------------------

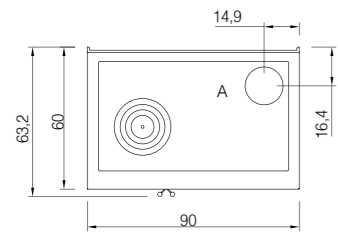

**KOOK 90 4.0**

SOPRA - TOP - SUPÉRIEUR - OBER

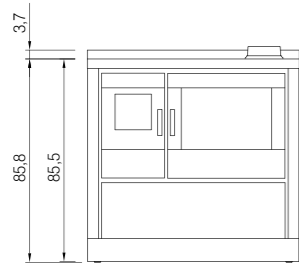

FRONTALE - FRONT - AVANT - VORDER

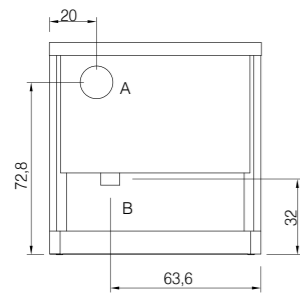

POSTERIORE - BACK - POSTÉRIEUR - HINTER



EUROPEAN STANDARDS

Art. 15A B-VG 2015
BlmSchV 2015
Regensburg
München
Stuttgart
Aachen

**TECHNICAL DATA****7,5 kW**

7,5 kW



82,5%



2,2 kg/h

180 m³

147,2 kg

L 42 cm
P 42 cm
H 29 cmL 17,2 cm
H 16,7 cmI h
4 cmL 97 cm
P 79 cm
H 102,1 cm0,78 m³

L 33 cm



Ø 140 mm



Ø 80 mm



Metallo Bianco
White Steel
Acier Blanc
Metall Weiss



Acciaio Inox
Inox Steel
Acier Inox
Edelstahl



Metallo Antracite
Anthracite Steel
Acier Anthracite
Metall Anthrazit



Metallo Nero
Black Steel
Acier Noir
Metall Schwarz

KOOK 90 4.0

71180050	EAN 8053859010524	Neutra / Neutral / Neutre / Neutral
71180051	EAN 8053859010531	Neutra / Neutral / Neutre / Neutral Kook 90 4.0 con kit ventilazione + luce Kook 90 4.0 with ventilation + light kit Kook 90 4.0 avec ventilation + éclairage Kook 90 4.0 mit Lüftung kit + Beleuchtung
6915051	EAN 8033123617116	Metallo Bianco / White Steel / Acier Blanc / Metall Weiss
6915036	EAN 8033123616829	Acciaio Inox / Inox Steel / Acier Inox / Edelstahl
6915035	EAN 8033123616812	Metallo Antracite / Anthracite Steel / Acier Anthracite / Metall Anthrazit
6915034	EAN 8033123616805	Metallo Nero / Black Steel / Acier Noir / Metall Schwarz

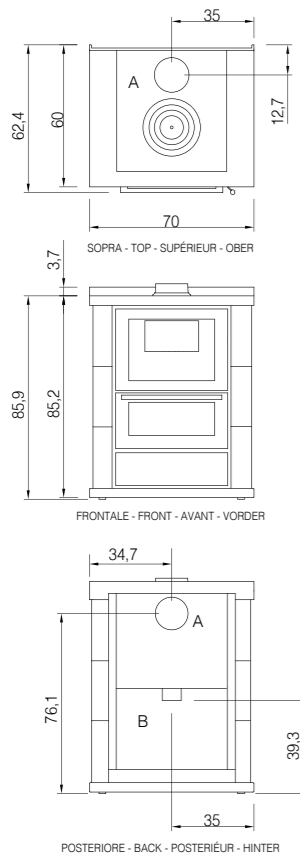

**KOOK 67 4.0**

EUROPEAN STANDARDS

Art. 15A B-VG 2015
BImSchV 2015
Regensburg
München
Stuttgart
Aachen



EN 12815:2001/A1:2004/AC:2007

**TECHNICAL DATA****6,2 kW**

6,2 kW



84,1%



1,7 kg/h

149 m³129,7 kg
145,8 kgL 37 cm
P 34 cm
H 16,5 cmL 26,1 cm
H 14,4 cmI h
4 cmL 77 cm
P 79 cm
H 100,5 cm0,61 m³

L 33 cm



Ø 140 mm



Ø 80 mm



Maiolica Avorio
Ivory Majolica
Céramique Ivoire
Keramik Elfenbein



Maiolica Rosso
Red Majolica
Céramique Rouge
Keramik Rot



Coperchio
Top
Couvercle
Deckel



Metallo Bianco
White Steel
Acier Blanc
Metall Weiss



Metallo Avorio
Ivory Steel
Acier Ivoire
Metall Elfenbein



Metallo Rosso
Red Steel
Acier Rouge
Metall Rot

KOOK 67 4.0

71190010	EAN 8053859010883	Neutra / Neutral / Neutre / Neutral
71190011	EAN 8053859010890	Kook 67 4.0 ventilata neutra Kook 67 4.0 ventilated stove neutral Kook 67 4.0 ventilé neutre Kook 67 4.0 neutral belüftet
6919001	EAN 8053859011163	Maiolica Avorio / Ivory Majolica / Céramique Ivoire / Keramik Elfenbein
6919002	EAN 8053859011170	Maiolica Rosso / Red Majolica / Céramique Rouge / Keramik Rot
6919005	EAN 8053859011200	Metallo Bianco / White Steel / Acier Blanc / Metall Weiss
6919003	EAN 8053859011187	Metallo Avorio / Ivory Steel / Acier Ivoire / Metall Elfenbein
6919004	EAN 8053859011194	Metallo Rosso / Red Steel / Acier Rouge / Metall Rot

OPTIONAL

5018015	EAN 8053859012863	Coperchio / Top / Couvercle / Deckel
---------	-------------------	--------------------------------------

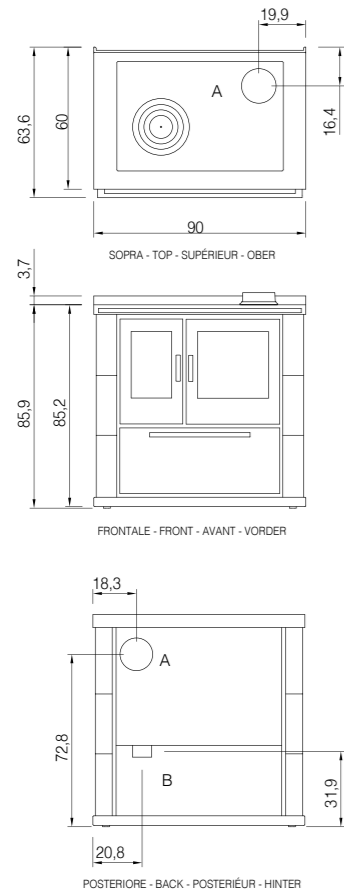

**KOOK 87**

EUROPEAN STANDARDS

Art. 15A B-VG 2015
BlmSchV 2015
Regensburg
München
Stuttgart
Aachen



EN 12815:2001/A1:2004/AC:2007

**TECHNICAL DATA****7,5 kW**

7,5 kW



82,5%



2,2 kg/h

180 m³142,7 kg
145,6 kgL 33 cm
P 42 cm
H 29 cmL 17,2 cm
H 16,7 cmI h
4 cmL 97 cm
P 79 cm
H 102,1 cm0,78 m³

L 33 cm



Ø 140 mm



Ø 80 mm

Coperchio
Top
Couvercle
DeckelMetallo Bianco
White Steel
Acier Blanc
Metall WeissMetallo Avorio
Ivory Steel
Acier Ivoire
Metall ElfenbeinMaiolica Avorio
Ivory Majolica
Céramique Ivoire
Keramik ElfenbeinMaiolica Rosso
Red Majolica
Céramique Rouge
Keramik RotMetallo Rosso
Red Steel
Acier Rouge
Metall Rot**KOOK 87**

71150050	EAN 8033123617215	Kook 87 neutra piano in ghisa / Kook 87 with cast iron Top / Kook 87 avec plaque en fonte / Kook 87 mit Gusseisen-Kochplatte
71150051	EAN 8033123617222	Kook 87 neutra piano in ghisa ventilata / Kook 87 with cast iron Top with ventilation + light kit / Kook 87 avec plaque en fonte avec ventilation + éclairage / Kook 87 mit Gusseisen-Kochplatte mit Lüftung kit + Beleuchtung
71150080	EAN 8033123617284	Kook 87 neutra piano in vetroceramica / Kook 87 with glass-ceramic Top / Kook 87 avec plaque vitrocéramique / Kook 87 mit Glaskeramik-Kochplatte
71150081	EAN 8033123617291	Kook 87 neutra piano in vetroceramica ventilata / Kook 87 with glass-ceramic Top with ventilation + light kit / Kook 87 avec plaque vitrocéramique avec ventilation + éclairage / Kook 87 mit Glaskeramik-Kochplatte mit Lüftung kit + Beleuchtung
6915028	EAN 8033123616416	Maiolica Avorio / Ivory Majolica / Céramique Ivoire / Keramik Elfenbein
6915029	EAN 8033123616423	Maiolica Rosso / Red Majolica / Céramique Rouge / Keramik Rot
6915050	EAN 8033123617109	Metallo Bianco / White Steel / Acier Blanc / Metall Weiss
6915026	EAN 8033123616553	Metallo Avorio / Ivory Steel / Acier Ivoire / Metall Elfenbein
6915027	EAN 8033123616560	Metallo Rosso / Red Steel / Acier Rouge / Metall Rot

OPTIONAL

5013003	EAN 8033123613361	Coperchio / Top / Couvercle / Deckel
---------	-------------------	--------------------------------------



CONDIZIONI GENERALI DI VENDITA	150
<ul style="list-style-type: none"> • Gli ordini assunti dai venditori sono sempre soggetti all’approvazione della Cadel. Se dopo l’approvazione si accertassero insolvenze del cliente, anche verso terzi, la Cadel potrà annullare l’ordine ammenoché il cliente aderisca al pagamento totale anticipato. • I termini di consegna concordati debbono sempre intendersi approssimativi. Ritardi eccessivi di consegna, per cause di forza maggiore, non danno diritto a risarcimento dei danni e ad annullamento di ordini per quanto già approntato. • Eventuali reclami dovranno essere comunicati per iscritto a mezzo raccomandata, entro otto giorni dal ricevimento della merce, trascorsi i quali non saranno più accettati. Gli stessi non sospendono i pagamenti delle fatture. • Le fatture si intendono accettate trascorsi otto giorni dal ricevimento. La Cadel è autorizzata ad emettere tratta a vista con spese, trascorso un giorno dal termine pattuito per il pagamento. • Sui pagamenti ritardati decorrono, senza pregiudizio di altra azione, gli interessi commerciali ufficiali. • I pagamenti dovranno essere effettuati unicamente al nostro domicilio alle condizioni pattuite. Non saranno riconosciuti validi i pagamenti fatti a persone o ditte da noi non autorizzate per l’incasso. • La vendita avverrà con riserva di proprietà a favore della Cadel fino ad avvenuto totale pagamento del prezzo rateato. • Il mancato pagamento, anche di una sola rata, darà diritto alla Cadel, fra l’altro, di ritirare la merce e di acquistare le rate pagate a titolo di risarcimento danni. Qualora il ritiro del materiale e l’incartamento delle rate non compensassero il danno della Cadel, la stessa avrà diritto di agire per la differenza in forza delle cambiali o delle tratte autorizzate e rilasciate originariamente a garanzia del puntuale pagamento delle rate. • Tutti i collaudi ufficiali ai quali saranno sottoposti i prodotti da noi trattati saranno a carico del cliente. Non si assumono oneri di collaudi in opera, salvo i nostri obblighi di garanzia ove previsti. Il tempo richiesto dai collaudi non è compreso nei termini di consegna. • Per ogni controversia si riconosce competente il foro di Treviso. • La Cadel non si assume responsabilità per interventi eseguiti da personale non autorizzato o da terzi, anche se da essa segnalati. • Privacy: i dati in nostro possesso e quelli eventualmente trasmessi saranno trattati nel rispetto di quanto disposto dal Codice in materia di protezione dei dati personali (D.L. 196/03). <p>Tutti i dati tecnici e traduzioni raccolte in questo catalogo/listino non possono ritenersi tassativi ma bensì indicativi. Inoltre, rese, m³, kW, si ritengono sempre in riferimento a prove di laboratorio, potrebbero variare se effettuate in altri locali. La ditta si riserva di apportare modifiche in qualsiasi momento e senza preavviso. I colori sono da considerarsi puramente indicativi.</p>	

GENERAL TERMS AND CONDITIONS OF SALE
<ul style="list-style-type: none"> • Vendor orders are always subject to Cadel’s approval. Cadel shall have the faculty of cancelling orders, should a customer’s insolvencies, even towards third parties, come to light, unless the customer opts for paying the entire due sum in advance. • The delivery schedule agreed to shall always be intended as approximate. Excessive delivery delays caused by force majeure shall not give rise to the right to compensation for damages or result in the cancellation of any orders that have already been prepared. • Complaints must be made in writing by means of registered post, eight days as of the date of receipt of the goods. No complaints shall be accepted following this deadline. The same do not suspend payments for invoices. • Invoices shall be intended as accepted as of eight days of receipt. Cadel shall be authorised to issue sight drafts with expenses, as of one day of the date agreed to for payment. • Official market interest rates shall be charged for any delays in payment, without prejudice to any other actions. • Payments must only be made to our address at the conditions agreed to. Payments made to companies or persons other than those authorised by us shall not be recognised. • Sales shall take place with reservation of title in favour of Cadel until all of the instalments due are paid. Failure to pay, even a single instalment, shall give Cadel the right, among other things, to collect the goods and acquire the instalments paid as compensation for damages. Should the restitution of the materials and receipt of the instalments not compensate Cadel for the damages suffered, the same shall have the right to take action with respect to the bills of exchanges or drafts issued originally as guarantee for the punctual payment of instalments. • All official tests performed on site on products that the company deals with shall be charged to the client. The company shall not be liable for the cost of tests performed on site, with the exception of the company’s warranty obligations, if any. The time required for the tests shall not be included in the delivery schedule. • The Courts of Treviso shall have jurisdiction over any controversies. • Cadel shall in no way be liable for interventions carried out by unauthorised staff or by third parties, even if named by the same. • Privacy: the data in our possession, and any data transmitted, shall be processed in adherence to the provisions of the Code on the protection of personal data (D.L. 196/03). • The conditions provided are intended as seen, approved, and accepted by the parties. <p>All of the technical information and translations provided this catalogue/price list are purely indicative and cannot be deemed to be definitive. Moreover, the yields, m³, and kW provided always refer to laboratory tests and may vary if carried out at other locations. The company reserves the right to make changes at any time, without prior warning. The colours provided are to be considered purely indicative.</p>

CONDITIONS GÉNÉRALES DE VENTE	151
<ul style="list-style-type: none"> • Les commandes reçues par les vendeurs sont dans tous les cas soumises à l’approbation de Cadel. En cas d’insolvabilité du client - y compris vis à vis de tiers - constatée après approbation, Cadel pourra annuler la commande ou imposer un paiement intégral anticipé. • Les délais de livraison fixés doivent être considérés comme approximatifs. En cas de retard excessif de livraison pour cause de force majeure, le client ne pourra avancer de demande d’indemnisation ni annuler la commande, cette dernière ayant déjà été préparée. • Les réclamations éventuelles doivent être adressées par écrit via lettre recommandée dans un délai maximum de 8 jours à compter de la réception de la marchandise pour être acceptées. Les réclamations n’autorisent pas à suspendre le paiement des factures. • Les factures sont considérées comme acceptées huit jours après leur réception. Cadel est autorisée à émettre des traites à vue avec frais après un jour de retard sur la date fixée pour le paiement. • En cas de paiement après l’échéance établie, les intérêts commerciaux officiels seront calculés, sans préjudice de l’action légale éventuellement intentée. • Les paiements devront être uniquement effectués à notre domicile et aux conditions établies. Les paiements effectués à des personnes ou des sociétés non autorisées par Cadel ne seront pas reconnus. • La vente est effectuée avec réserve de propriété à faveur de Cadel jusqu’au paiement intégral du prix. En cas de non-paiement, y compris d’une seule traite, Cadel aura le droit, entre autres, de retirer la marchandise et de retenir les traites déjà payées à titre de dédommagement. Dans le cas où le retrait du matériel et la valeur des traites ne compenseraient pas le préjudice subi par Cadel, cette dernière aura le droit d’agir en justice pour la différence en vertu des billets à ordre ou des traites autorisées et remises à l’origine à titre de garantie d’un paiement ponctuel des traites. • Tous les essais officiels auxquels seront soumis nos produits sont à la charge du client. Aucune vérification des produits posés n’est prise en charge, à l’exception de nos obligations en matière de garantie. Le temps nécessaire aux essais n’est pas compris dans les délais de livraison. • Le tribunal de Trévis est seul compétent en cas de litige. • Cadel décline toute responsabilité en cas d’interventions effectuées par un personnel non autorisé ou par des tiers, y compris si ces derniers ont été signalés par Cadel. • Confidentialité: les informations qui nous sont soumises ou, le cas échéant, qui nous sont transmises seront traitées conformément au Code de protection des informations personnelles (D.L. 196/03). • Les conditions indiquées sont considérées comme vues, approuvées et acceptées par les parties. <p>Toutes les informations techniques et les traductions de ce catalogue/liste des prix sont fournies à titre exclusivement indicatif. En outre, les rendements, m³ et kW se réfèrent dans tous les cas aux essais de laboratoire et peuvent donc varier selon les différentes installations. La société se réserve le droit d’apporter des modifications à tout moment et sans préavis. Les couleurs sont uniquement indicatives.</p>	

ALLGEMEINE VERKAUFSBEDINGUNGEN
<ul style="list-style-type: none"> • Die von den Verkäufer übernommenen Bestellungen müssen immer von Cadel genehmigt werden. Sollte der Kunde nach der Genehmigung auch gegenüber Dritten insolvent sein, kann Cadel die Bestellung stornieren, außer wenn der Kunde im Voraus die gesamte Zahlung leistet. • Die vereinbarten Lieferfristen sind immer als nicht verbindlich zu verstehen. Große Lieferverzögerungen aufgrund höherer Gewalt berechtigen nicht zum Schadenersatz oder zur Stornierung der Bestellungen, wenn diese zur Auslieferung bereit sind. • Eventuelle Beanstandungen müssen innerhalb von 8 Tagen nach Erhalt der Ware mittels eines Einschreibebriefs gemeldet werden. Nach Ablauf dieser Frist werden Reklamationen nicht mehr angenommen. Beanstandungen heben die Zahlungspflicht nicht auf. • Die Rechnungen werden 8 Tage nach Erhalt als akzeptiert betrachtet. Cadel ist ein Tag nach Ablauf der vereinbarten Zahlungsfrist berechtigt, eine Sichttratte einschließlich Spesen zu ziehen. • Bei Zahlungsverzug werden unbeschadet aller weiteren Vorgehensweisen die offiziellen Handelszinsen dazu berechnet. • Die Zahlungen müssen ausschließlich zu den vereinbarten Bedingungen an unsere Dienstanschrift geleistet werden. Zahlungen, die an Personen oder Firmen geleistet werden, die nicht von uns zum Inkassot berechtigt wurden, haben keine Gültigkeit. • Der Verkauf erfolgt unter Eigentumsvorbehalt zugunsten von Cadel bis zur vollständigen Zahlung der Raten. Das Ausbleiben der Zahlung, auch von nur einer Rate, berechtigt Cadel unter anderem, die Ware zurückzunehmen und die gezahlten Raten als Schadenersatz einzubehalten. Kann die Rücknahme des Materials und die Erhöhung der Raten den Schaden von Cadel nicht ausgleichen, ist Cadel berechtigt, auf Grund der ursprünglich als Garantie akzeptierten und ausgestellten Wechsel bzw. Tratten, für die Differenz den Rechtsweg zu gehen. • Alle offiziellen Abnahmeprüfungen, denen die von uns gelieferten Produkte unterzogen werden, gehen zulasten des Kunden. Es werden keine Kosten für Abnahmeprüfungen übernommen, außer im Fall von Garantieverpflichtung unsererseits, wo dies vorgesehen ist. Die für die Abnahmeprüfung benötigte Zeit ist im Liefertermin nicht berücksichtigt. • Für jeden Rechtsstreit ist der Gerichtsstand Treviso zuständig. • Cadel übernimmt für von unbefugtem Personal oder von Dritten ausgeführte Eingriffe keine Haftung, auch wenn diese Eingriffe von Cadel selbst als notwendig angegeben wurden. • Datenschutz: die Daten, die sich in unserem Besitz befinden, und diejenigen, die eventuell übermittelt werden, werden gemäß der Bestimmungen der Gesetzgebung zum Datenschutz vertraulich behandelt (Gesetzesdekret 196/03). • Die aufgeführten Bedingungen verstehen sich als von den Vertragspartnern eingesehen, genehmigt und akzeptiert. <p>Alle technische Daten und Übersetzungen die in dieser Katalog/Preisliste versammelt sind, dürfen nicht als bindend sondern als ungefähr berücksichtigt werden. Außerdem beziehen sich Leistungen, m³ und kW-Daten immer an Laborproben, deshalb könnten sie sich ändern, wenn in anderen Räumen durchgeführt werden. Die Firma hat die Fähigkeit, Änderungen in jeder Zeit und ohne Ankündigung vorzunehmen. Farben sind demonstrativ.</p>



ASSISTENZA COMPLETA

RICHIEDERE SEMPRE UN INSTALLATORE QUALIFICATO

ASSISTENZA ED INSTALLAZIONI

- Ricordiamo che prima di usare il generatore di calore è necessario leggere attentamente il libretto istruzioni.
- Prima di contattare il produttore si prega di aver verificato quanto specificato.
- Per installazioni di camini o canali da fumo affidarsi ad un tecnico specializzato il quale seguirà scrupolosamente tutte le regole imposte nella EN 10683.
- L'azienda non risponderà per installazioni eseguite senza rispetto delle normative di legge.
- Invitiamo tutti i clienti a leggere la garanzia prima di usufruire del servizio tecnico.

IN CASO DI SUPPORTO TECNICO

- In caso di inconveniente sul prodotto, contattare il proprio negoziante che potrà assistervi direttamente o mettervi in contatto con la rete di assistenza ufficiale CADEL.
- Per richiedere l'intervento di un centro assistenza autorizzato CADEL è possibile anche consultare il nostro sito internet www.cadelsrl.com ed individuare il tecnico più vicino alla vostra abitazione.
- Ricordiamo che per avere diritto alla garanzia di legge di presentare al centro assistenza autorizzato sempre la documentazione d'acquisto e le certificazioni di installazione.

COMPLETE ASSISTANCE

PLEASE ALWAYS REQUEST A SKILLED INSTALLER

ASSISTANCE AND INSTALLATIONS

- We remind that before using your heat generator it is necessary to read carefully the instruction manual.
- Before contacting the manufacturer please check what specified.
- To install chimneys or fume conduits please contact a specialized technician who will carefully follow all regulations provided by EN 10683.
- The manufacturer will not be responsible for installations made without compliance with laws.
- We invite all customers to read the warranty before benefiting from technical assistance service.

IN CASE OF TECHNICAL SUPPORT

- In case of product failure, please contact your retailer who either will directly give you assistance or will get in contact with CADEL's official service network.
- To request the intervention of a CADEL's authorized assistance service you can consult our web site www.cadelsrl.com and seek your nearest technician
- We remind you that to benefit from warranty provided by the law you have always to submit to the authorized assistance service the required purchasing documents and installation certificates.

ASSISTANCE COMPLÈTE

TOUJOURS S'ADRESSER À UN TECHNICIEN AGRÉÉ

ASSISTANCE ET MONTAGES

- Nous vous rappelons que avant d'utiliser l'appareil il est nécessaire de lire attentivement la notice d'utilisation.
- Avant de contacter le producteur nous vous prions de vérifier ce qui est indiqué dans la notice.
- Pour les installations de cheminées et de conduits de fumées s'adresser à un technicien agréé qui suivra scrupuleusement les normes imposées par la normative EN 10683.
- La société ne peut pas répondre pour les travaux effectués en dehors du respect des normes en vigueur.
- Nous invitons tous les clients à lire la garantie avant de contacter le service technique.

EN CASE DE SUPPORT TECHNIQUE

- En cas d'inconvénients avec le produit, nous vous prions de contacter votre revendeur, qui pourra vous fournir assistance directement ou vous mettre en contact avec le centre SAV CADEL plus proche.
- Pour demander l'intervention d'un centre SAV CADEL ils est possible de consulter notre site internet www.cadelsrl.com pour trouver le technicien le plus proche.
- Nous vous rappelons que pour avoir droit à la garantie ils faut toujours présenter au centre de SAV agréé toute la documentation d'achat et les certificats d'installation.

KUNDENDIENST

FRAGEN SIE BITTE FACHPERSONAL

KUNDENDIENST UND INSTALLATIONEN

- Bevor die Aufstellung benützt wird, muss der Benutzer die Gebrauchsanleitung aufmerksam lesen.
- Weisen Sie bitte, was bestimmt ist nach, bevor der Hersteller zu kontaktieren
- Installationen von Kaminen oder Abzügen müssen von qualifiziertem und autorisiertem Fachpersonal gemäß EN 10683 Rechtsvorschrift durchgeführt werden.
- Die Firma wird nicht verantwortlich sein, falls Installationen nicht gemäß den Rechtsvorschriften durchgeführt werden.
- Der Benutzer soll die Garantiebedingungen lesen bevor den Kundendienst zu kontaktieren

BEI TECHNISCHER ÜNTERSTÜTZUNG

- Bei Problemen mit dem Produkt, wenden Sie sich den Händler oder das von Cadel autorisiertes Fachpersonal an.
- Um CADEL technische Unterstützung zu bitten, fragen Sie BITTE unsere website www.cadelsrl.com ab, um der nächsten Fachpersonal zu finden.
- Damit die Garantie gültig und wirksam wird, muss der Benutzer dem autorisierten Fachpersonal beim Kaufzeitpunkt ausgestellten Beleg und Installationbescheinigung vorweisen.



cadelsrl.com



TECHNICAL DATA



Potenza nominale
Nominal power
Puissance nominale
Nennleistung



Potenza ridotta
Reduced power
Puissance reduite
Verminderte Leistung



Rendimento nominale
Nominal performance
Rendement nominal
Wirkungsgrad bei Nennleistung



Rendimento ridotto
Reduced performance
Rendement réduit
Wirkungsgrad bei verminderter Leistung



Potenza utile all'acqua nominale
Nominal useful water power
Puissance utile à l'eau nominale
Nennwärmeleistung - Wasseranteil



Potenza utile all'acqua ridotta
Reduced useful water power
Puissance utile à l'eau reduite
Min - Nennwärmeleistung - Wasseranteil



Volume riscaldabile min/max
Heatable volume min/max
Volume à chauffer min/max
Raumheizvermögen min/max



Capacità serbatoio
Hopper capacity
Capacité de réservoir
Inhalt Pelletbehälter



Combustibile pellet
Pellet fuel
Combustible granulés
Brennstoff Pellet



Combustibile legna
Wood fuel
Combustible bois
Brennstoff Holz



Consumo orario min/max
Hourly consumption min/max
Consommation horaire min/max
Verbrauch pro Stunde



Autonomia min/max
Range min/max
Autonomie min/max
Autonomie min/max



Decibel
Decibel
Décibel
Dezibel



Peso netto
Net weight
Poids net
Nettogewicht



Misure imballo
Packing dimensions
Volume mesures
Verpackung Ausmaße



Volume imballo
Packing volume
Volume emballage
Verpackungsvolumen



Misure forno
Oven dimensions
Mesures four
Backofenmaße



Misure bocca fuoco
Fire box dimensions
Mesures entree foyer
Feuerstellemaße



Altezza piano
Cooktop height
Hauteur plan de cuisson
Kochfeldshöhe



Scarico fumi
Exhaust fumes
Tuyau d'évacuation
Rauchabzug



Preso aria comburente
Hole combustion air inlet
Prise d'air comburant
Öffnungen für die Verbrennungsluft



Uscita canalizzazione
Ducting outlet
Canalisation
Kanalauslass



CADEL S.r.l. - Via Foresto sud, 7
31025 Santa Lucia di Piave (TV) Italy
Tel. +39 0438 738669 - Fax +39 0438 73343
customer care@cadelsrl.com - www.cadelsrl.com



MADE IN ITALY